

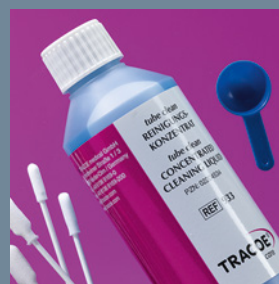

**PRODUCT  
CATALOG**  
QUALITY  
BY PEOPLE  
FOR PEOPLE

**TRACOE®**



# REF Numbers Overview













REF	Page	REF	Page	REF	Page	REF	Page
<b>TRACOE percutan</b>		309	33	108	64	650-TO-C	80
320	19	311	34	114	64	655-S	83
321	19	311-P	35	115	62	655-T	82
322	19	312	34	157	65	<b>TRACOE technic</b>	
888-322	19	312-P	35	158	65	702	89
330	19	313	34	164	65	720	90
331	19	314	35	201	55	721	90
332	19	316	36	202	55	725	91
888-332	19	316-P	37	202-D	55	730-5	88
420	18	888-316	36	203	57	<b>TRACOE select</b>	
421	18	888-316-P	37	203-A	57	820	94
422	18	401	38	203-O	57	850-5	95
423	18	501	38	204	59	<b>TRACOE care</b>	
424	18	503	38	204-A	61	677	102
425	18	506	38	204-A-O	61	902	102
517	15	521	39	204-O	59	903	98
518	15	523	39	205	63	905	104
520	15	<b>TRACOE kids</b>		215	63	907	104
<b>TRACOE vario</b>		350	49	<b>TRACOE larynx</b>		908	103
450	22	355	49	580	72	909	103
450-P	23	356	49	581	72	910	104
451	24	360	47	582	72	915	103
451-P	25	361	47	583	72	919	107
455	22	362	47	601	73	921	107
460	22	363	47	602	73	923	107
460-P	23	370	48	603	73	930	100
461	24	371	48	607-45	74	931	101
461-P	25	372	48	607-70	74	932	100
464	23	373	48	612	72	933	101
470	22	<b>TRACOE comfort</b>		613	72	934	100
470-P	23	101	54	660	74	935	100
471	24	102	54	<b>TRACOE modular</b>		936	101
471-P	25	102-D	54	516	82	938	102
<b>TRACOE twist</b>		103	56	621	83	940	103
301	30	103-A	56	622	85	957	105
301-P	31	103-A-O	58	640-CT	84	958	106
302	30	103-O	56	640-S	85	959	106
302-P	31	104	58	641	84	960	105
303	30	104-A	60	642	84	961	105
304	31	104-A-O	60	643	84	969	106
305	32	104-O	58	645	82	970	102
306	32	105	62	650-S	81		
306-P	33	105-D	62	650-SO	81		
888-306	32	106-D	54	650-T	80		
888-306-P	33	107	64	650-TO	80		

# Colour Coding & Legend to Symbols

## Colour Coding

The colour coding should help you see the properties of the tube at a glance. All outer packaging of the *twist*, *vario* and *kids* product lines is colour coded in this way.









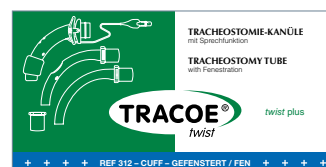

- |  |   |
|--|---|
|  TRACOE tracheostomy tube without extras  |  TRACOE tracheostomy tube for neonates                               |
|  TRACOE tracheostomy tube with cuff   |  TRACOE tracheostomy tube for children                               |
|  TRACOE fenestrated tracheostomy tube   |  TRACOE fenestrated tracheostomy tube with cuff                      |
|  TRACOE tracheostomy tube with subglottic suction line and cuff                     |  TRACOE tracheostomy tube with cuff and air supply line for speaking |
|  TRACOE tracheostomy tube with subglottic suction line, fenestrated and with cuff |  TRACOE tracheostomy tube for neonates, with H <sub>2</sub> O cuff |
|  TRACOE tracheostomy tube for laryngectomised patients                            |  TRACOE tracheostomy tube for children, with H <sub>2</sub> O cuff |

## Legend to Symbols

Like the colour coding, the symbols should help you to identify the main specifications of the tube. These symbols also appear on the outer packaging.



- |  |  |
|--|--|
|  the black stripes indicate a spiral-reinforced tracheostomy tube |  the plus symbol indicates the plus product lines <i>comfort plus</i> and <i>twist plus</i> |
|  PL means a 'proximal longer' tracheostomy tube                   |  XL indicates an extra-long tracheostomy tube   |
|  TRACOE tracheostomy tube for neonates and infants                |  speaking valve or fenestrated tracheostomy tube with integrated speaking valve             |
|  TRACOE tracheostomy tube for children                            |  fenestrated tracheostomy tube  |

# TRACOE Product Portfolio

## **Editorial** **2**

The TRACOE Group –  
Quality by People for People

## **TRACOE *percutan*** **12**

TRACOE *experc* sets for  
percutaneous dilation tracheostomy  
(PDT)

## **TRACOE *vario*** **20**

Tracheostomy tubes with variably  
adjustable neck flange

TRACOE *vario* Page 22

TRACOE *vario* XL Page 24

## **TRACOE *twist*** **28**

Tracheostomy tubes with inner  
cannulas and adjustable neck flange

TRACOE *twist* Page 30

TRACOE *twist* plus Page 34

## **TRACOE *kids*** **44**

Tracheostomy tubes designed to  
meet the special requirements of  
neonates and children

TRACOE *silcosoft* Page 46

TRACOE *mini* Page 49

## **TRACOE *comfort*** **52**

Tracheostomy tubes with inner  
cannulas for long-term use

TRACOE *comfort* Page 54

TRACOE *comfort* XL Page 55

TRACOE *comfort* plus Page 65

## **TRACOE *larynx*** **70**

stoma and grid buttons, silicone short  
tubes, adhesive carriers and  
button plus

## **TRACOE *modular*** **76**

Speaking valves, heat/moisture  
exchanger

## **TRACOE *technic*** **86**

Precision medical products for the  
cuff pressure management

## **TRACOE *select*** **92**

Selected medical devices from  
external manufacturers

## **TRACOE *care*** **96**

Accessories for product care,  
cleaning and maintenance

## **Contact and Information** **108**

Contact and information about use  
and maintenance of tracheostomy  
tubes



# DYNAMIC FORCES & VISIONARIES

## **Working together to achieve common goals**

TRACOE is a community of committed co-workers with a common goal – to develop, produce, and distribute great products successfully and sustainably.

We are one big family made up of TRACOE medical GmbH, MC Europe B.V. and KAPITEX Healthcare Ltd. People with a very special company vision are the reason for the long-term success of the TRACOE company group. Flat organisational structures and a shared sense of trust are just as integral to our culture as uncompromising quality and innovative products. These values form our common understanding and drive our future growth.

Together, we want to help improve the quality of life for patients and increase treatment success for medical staff – Quality by People for People.





# FAMILY BUSINESS OWNER & GLOBAL PLAYER

Stephan Köhler

## From garage start-up to global company

Stephan Köhler, Managing Director of TRACOE medical, has literally grown up with TRACOE and is the third generation to run the family business. Since 1990, he has been realising his vision and grown the company into a global player. The family atmosphere, motivated staff, and not least the innovative products define the image of TRACOE today. Short communication channels with customers, permanent points of contact in the national and international sales teams, and fast reaction times guarantee high reliability for our customers. We take customer service seriously.

The production site in Germany is an important part of the strategy, to ensure the quality and stability associated with "Made in Germany". We want to grow sustainably without losing the special character of a medium-sized family business. An additional production facility for silicone in Nieder-Olm is a clear continuation of this strategy. Customers can rely on new, high-quality products and an ever-expanding range.



# PIONEER & REFORMER

Dr. Thomas Jurisch

## Enabling growth to stay ahead of the game

Dr. Thomas Jurisch has been the second managing director since 2014. With his vision and a structured approach, he provides essential support for TRACOE. His main objective is to guarantee the future viability of TRACOE in all areas by optimising the organisational structure and processes. This includes ensuring effectiveness and efficiency through transparency at all levels and the gradual digital transformation of business processes. With enterprising decisions, he and his team are guiding the technology into the 21<sup>st</sup> century. Reconstructing and extending production has helped us to understand and respond more quickly to client requirements – from development to the finished product.

At the same time, global regulatory requirements on the medical technology market are also becoming more demanding. Process optimisation and quality management are therefore essential to face future challenges. Last but not least, the company is driven by Research & Development, which provides the innovative force to develop quality hi-tech medical devices for the well-being of our customers.







# NETWORKER & LATERAL THINKER

Richard van Goor

## Great achievements with minimal resources

Founded in 2010, MC Europe B.V. has been part of the TRACOE group since 2011. Using his extensive clinical know-how and relying on a professional and effective team, managing director and co-owner Richard van Goor has succeeded in building up markets in the entire Benelux area.

The company specialises in mechanical ventilation and excels through the use of innovative and high-quality medical devices – combined with expert advice for the customer. Richard van Goor and his team work with leading manufacturers from all over the world to develop pragmatic solutions and innovative products. This approach is of prime importance in the TRACOE Group, as the wealth of experience provides new impetus for product development and marketing strategies, benefitting doctors and patients alike.



# INNOVATOR & OPTIMISER

Ian D. Worthington

## Thinking outside the box and creating new structures

A longstanding collaborative partner of many years has now become a sister company of TRACOE: KAPITEX Healthcare Ltd. has been part of the TRACOE family since 2016. Managing partner Ian Worthington has developed a similar culture with his team in Great Britain as that of TRACOE in Germany: informal atmosphere, flat hierarchies and customer communication based on mutual trust. The passionate developer and designer has modernised the company and has a clear vision for its future.

“Airway intelligence” is their passion. The company primarily specialises in airway management – maintaining and ensuring respiratory function in tracheostomy and laryngectomy patients. KAPITEX also develops and manufactures its own products, which makes it the perfect sister company. The amalgamation of the two companies has resulted in both of them being able to offer a more complete and extensive product range. This variety of products not only benefits the group, but our customers too.







## A Proven Technique

Percutaneous dilatation tracheotomy (PDT) has become routine practice in intensive care. The Ciaglia technique is now the method most widely used. The TRACOE expert system is based on this proven technique.

The sets are tailored to the use of fenestrated and non-fenestrated tracheostomy tubes, including tubes with sub-glottic suction lines, from the TRACOE *twist*, *twist plus*,

and TRACOE *vario* product lines. They are supplied already mounted on their minimally traumatic insertion systems (P-tubes). Inserting the tube into the patient via an introducer is a particular challenge of the percutaneous dilatation.





## Our Innovation

Thanks to the patented minimally traumatic inserter and minimally traumatic insertion system, TRACOE experc sets offer the solution: the soft silicone sleeve at the tip of the instrument smoothly bridges the gap in diameter between the inserter and the tube, thus allowing the tube to be introduced safely and easily.

## The Variable System

The TRACOE *twist*, including *twist plus*, and TRACOE *vario* product lines include 14 different P-tubes (all DEHP-free) with a minimally traumatic insertion system. Six of these tubes have subglottic suction lines. Sets are available in sizes 07 – 09. The TRACOE *twist plus* also comes in size 10. The TRACOE experc sets can therefore be used with the tracheostomy tube that is most appropriate for the patient.

# The Variable Packaging System



Outer packaging of the TRACOE experc dilation set without tube (REF 520).



Outer packaging of the TRACOE experc Set *vario* and *vario* XL and the packaging of the corresponding P-tube.



Outer packaging of the TRACOE experc Set *twist* and the packaging of the corresponding P-tube.



Outer packaging of the TRACOE experc Set *twist* plus and the packaging of the corresponding P-tube.

The TRACOE *percutan* product line offers the possibility of ordering the dilatation set alone or as a set including a P-tube from the *twist*, *twist* plus, *vario* and *vario* XL product lines.

The special feature of the pre-mounted tube is its unique minimally traumatic inserter, which perfectly complements the percutaneous dilatational tracheotomy procedure. You will find details of the various inserters and how they function on the following pages.

**REF 520**

**TRACOE experc Dilator Set**  
for percutaneous tracheotomy

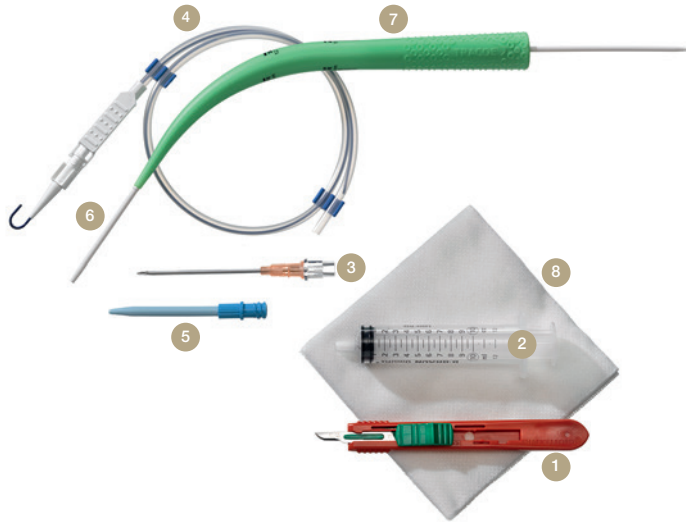

- 1 scalpel
- 2 syringe
- 3 puncture needle (14 G) with teflon catheter
- 4 seldinger guide wire made of kink resistant Nitinol with inserter
- 5 short dilator (14 Ch/Fr)
- 6 guiding catheter with safety stop
- 7 TRACOE experc dilator with hydrophilic coating (slides easily after moistening)
- 8 4 compresses

◆ in sterile package

The TRACOE experc dilatation set (REF 520) can be used alone or together with the P-tube most appropriate for the patient. You will find an overview on pages 18/19.

▶ Learn more in our product video on our website [www.tracoe.com/en/media-library](http://www.tracoe.com/en/media-library)

**REF 517**

**TRACOE *percutan* Seldinger Guide Wire**  
made of kink resistant Nitinol, with guiding catheter

◆ in sterile package

To be used with all TRACOE *twist* tubes with minimally traumatic inserter.

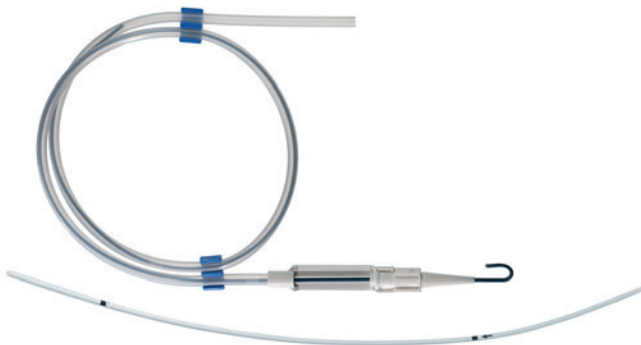

**REF 518**

**TRACOE *percutan* Seldinger Guide Wire**  
made of kink resistant Nitinol

Packaging unit: ◆ 5 units  
◆ sterile, individually packaged

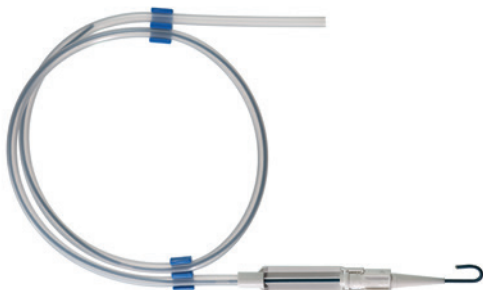

# The Minimally Traumatic Inserter

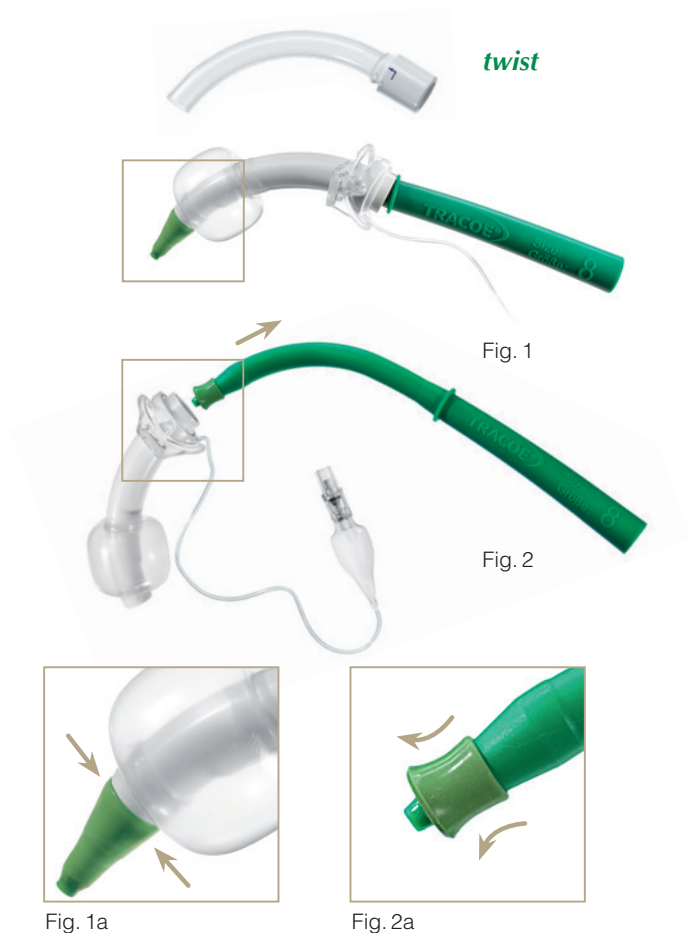

At the tip of the *twist* inserter, there is a folding silicone sleeve that smoothly bridges the gap in diameter between the inserter and the end of the tube (Fig. 1a).

The minimally traumatic inserter is accurately adapted to the tube and its size. That prevents the tube from slipping. Once the tube is in the trachea, the inserter is pulled out of the tube. The silicone sleeve flaps back to facilitate its easy removal (Fig. 2, 2a).

## The Benefits

Dilatation is performed using the Ciaglia one-step technique. The minimally traumatic inserter smooths over the gap in diameter between the end of the tube and the inserter. This minimises the risk of injury when the tracheostomy tube is introduced into the trachea. The stop at the proximal end of the tube prevents the inserter from being inserted too far into the tube, which also reduces the risk of injury.

The separately available P-tubes can also be used for reinsertion and/or for tube change – in combination with a Seldinger guide wire, if necessary (see page 15).

# The Minimally Traumatic Insertion System

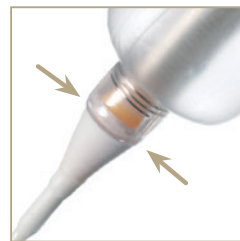
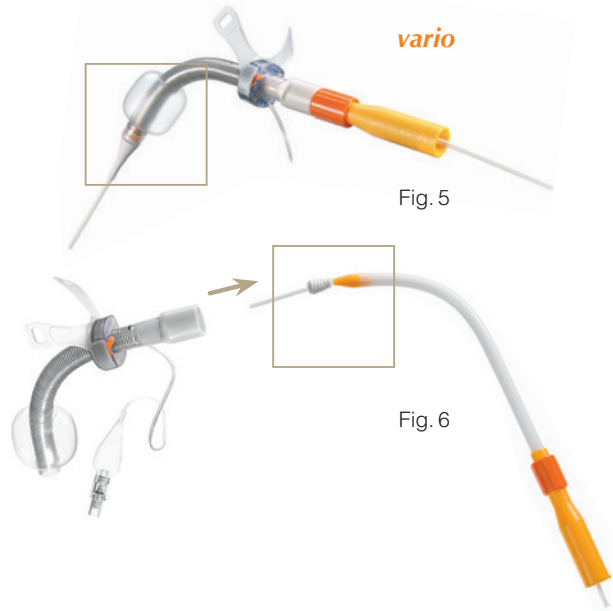
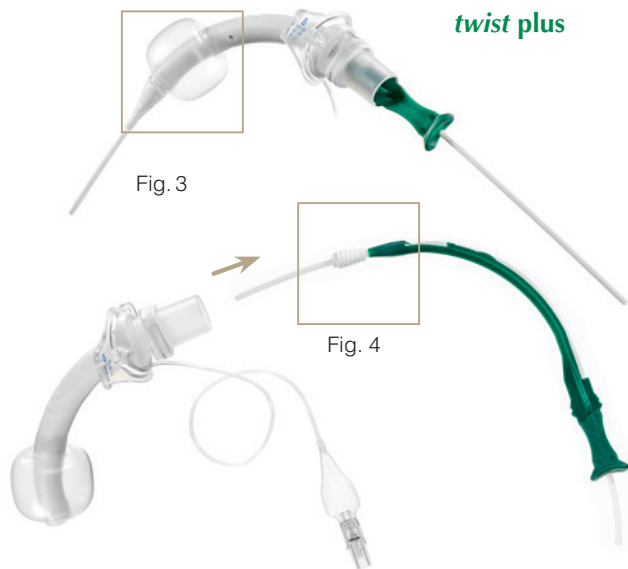

Fig. 3a

Fig. 4a

Fig. 5a

Fig. 6a

The systems for *twist plus* and *vario* consist of two parts: the white guiding catheter with silicone sleeve and the green (*twist plus*) or orange (*vario*) inserter. The silicone sleeve smoothly bridges the gap in diameter between the end of the tube and the inserter, thus minimising the risk of injury when the tracheostomy tube is inserted into the trachea (Fig. 3a, 5a).

The *twist plus* tracheostomy tube is supplied premounted on the minimally traumatic insertion system, with the inner cannula already in place. The insertion system stabilises

and facilitates guiding the tube. The inserter fits precisely into the tube and has a stop at the 15mm connector. Once the tube is in the trachea, the coloured inserter, the white guiding catheter with the silicone sleeve, and the Seldinger guide wire are removed together as a single unit. The silicone sleeve now flaps back, allowing the guiding catheter to be removed easily (Fig. 4a, 6a).

Alternatively, the coloured inserter can be pulled out of the tube first, followed by the white guiding catheter and Seldinger guide wire. The white guiding catheter must never be removed first.

**experc Sets vario**



REF 420 

**TRACOE experc Set vario including REF 450-P**  
spiral-reinforced, with adjustable neck flange, cuff and minimally traumatic insertion system  
Details on page 23/26



REF 422 

**TRACOE experc Set vario extract including REF 470-P**  
with adjustable neck flange, cuff, subglottic suction line and minimally traumatic insertion system  
Details on page 23/26



REF 423 

**TRACOE experc Set vario including REF 460-P**  
with adjustable neck flange, cuff and minimally traumatic insertion system  
Details on page 23/26

**experc Sets vario XL**



REF 421 

**TRACOE experc Set vario XL including REF 451-P**  
extra-long, spiral-reinforced, with adjustable neck flange, cuff and minimally traumatic insertion system  
Details on page 25/26



REF 425 

**TRACOE experc Set vario extract XL including REF 471-P**  
extra-long, with adjustable neck flange, cuff, subglottic suction line and minimally traumatic insertion system  
Details on page 25/26



REF 424 

**TRACOE experc Set vario XL including REF 461-P**  
extra-long, with adjustable neck flange, cuff and minimally traumatic insertion system  
Details on page 25/26

## experc Sets *twist*



REF 320 

TRACOE experc Set *twist* including REF 301-P with cuff and minimally traumatic inserter  
Details on page 31/40



REF 321  

TRACOE experc Set *twist* including REF 302-P with cuff, fenestrated and minimally traumatic inserter  
Details on page 31/40



REF 322 

TRACOE experc Set *twist* including REF 306-P with cuff, subglottic suction line and minimally traumatic inserter  
Details on page 33/40



REF 888-322  

TRACOE experc Set *twist* including REF 888-306-P with cuff, fenestrated, subglottic suction line and minimally traumatic inserter  
Details on page 33/40

## experc Sets *twist plus*



REF 330 

TRACOE experc Set *twist plus* including REF 311-P with cuff and minimally traumatic insertion system  
Details on page 35/41



REF 331  

TRACOE experc Set *twist plus* including REF 312-P with cuff, double fenestrated and minimally traumatic insertion system  
Details on page 35/41



REF 332 

TRACOE experc Set *twist plus* including REF 316-P with cuff, subglottic suction line and minimally traumatic insertion system  
Details on page 37/41



REF 888-332 

TRACOE experc Set *twist plus* including REF 888-316-P with cuff, double fenestrated, subglottic suction line and minimally traumatic insertion system  
Details on page 37/41



## Patented Precision Work

TRACOE *vario* is a soft, flexible (DEHP-free) tube with a patented adjustable neck flange. By means of a practical push-button mechanism, the flange can be moved and adjusted to the individual patient. In this way, the correct length can be achieved. A scale ensures the exact positioning of the neck flange in preparation for a tube change.

Positioning the flange by using the grey push-button and locking it by moving the orange lever upwards. Since no screw closure is used, no pressure at all is exerted on the trachea.





## Highly Adaptable

The flexible wings on the flange of the TRACOE *vario* tube can be adjusted independently of one another, providing further opportunities to accommodate the individual patient's anatomy. The right solution for each patient can be selected from the eight types of TRACOE *vario* tracheostomy tube available: whether reinforced with a metal spiral, made of transparent plastic (with radio-opaque contrast lines), fenestrated, with or without a cuff.

The extra-long TRACOE *vario* XL with metal spiral and TRACOE *vario* extract in transparent plastic equipped with a subglottic suction line, both with cuffs, are special varieties – naturally also available in the standard lengths.



REF 450



**TRACOE *vario* Tracheostomy Tube**  
 spiral-reinforced, with adjustable neck flange,  
 low pressure cuff, scale and 15 mm connector

Including: ♦ obturator and neck strap  
 ♦ in sterile package



REF 460



**TRACOE *vario* Tracheostomy Tube**  
 with adjustable neck flange, low pressure cuff,  
 X-ray contrast line, scale and 15 mm connector

Including: ♦ obturator and neck strap  
 ♦ in sterile package



REF 470



**TRACOE *vario* extract Tracheostomy Tube**  
 with adjustable neck flange, low pressure cuff,  
 subglottic suction line, X-ray contrast line, scale  
 and 15 mm connector

Including: ♦ 2 connectors for suction pump  
 ♦ obturator and neck strap  
 ♦ in sterile package



REF 455



**TRACOE *vario* Tracheostomy Tube**  
 spiral-reinforced, with adjustable neck flange,  
 scale and 15 mm connector

Including: ♦ obturator and neck strap  
 ♦ in sterile package



REF 450-P



**TRACOE vario Tracheostomy Tube**  
with minimally traumatic insertion system, spiral-reinforced, adjustable neck flange, low pressure cuff, scale and 15 mm connector

- Including:
- ◆ lubricating gel
  - ◆ obturator and neck strap
  - ◆ in sterile package

As percutaneous set in REF 420

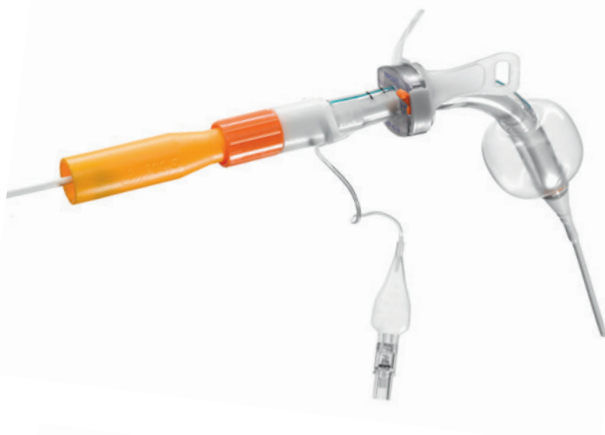

REF 460-P



**TRACOE vario Tracheostomy Tube**  
with minimally traumatic insertion system, adjustable neck flange, low pressure cuff, X-ray contrast line, scale and 15 mm connector

- Including:
- ◆ lubricating gel
  - ◆ obturator and neck strap
  - ◆ in sterile package

As percutaneous set in REF 423

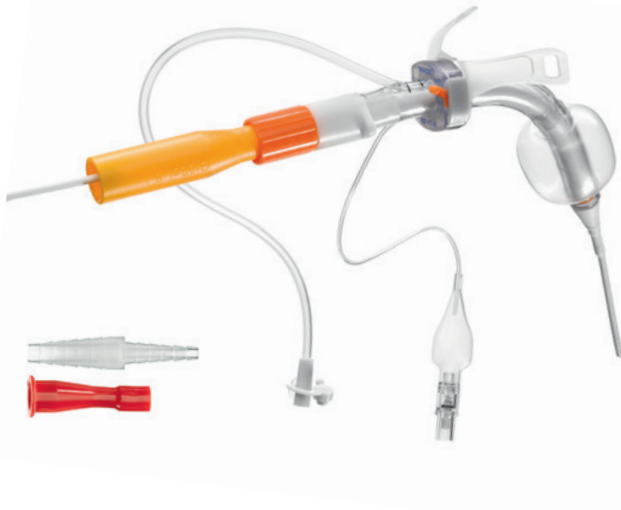

REF 470-P



**TRACOE vario extract Tracheostomy Tube**  
with minimally traumatic insertion system, adjustable neck flange, low pressure cuff, subglottic suction line, X-ray contrast line, scale and 15 mm connector

- Including:
- ◆ lubricating gel
  - ◆ 2 connectors for suction pump
  - ◆ obturator and neck strap
  - ◆ in sterile package

As percutaneous set in REF 422



REF 464



**TRACOE vario Tracheostomy Tube**  
with adjustable neck flange, fenestrated, X-ray contrast line, scale and 15 mm connector

- Including:
- ◆ obturator and neck strap
  - ◆ in sterile package



REF 451 **XL**

**TRACOE *vario* XL Tracheostomy Tube**  
 spiral-reinforced, with adjustable neck flange,  
 low pressure cuff, scale and 15 mm connector

- Including:
- ◆ obturator and neck strap
  - ◆ in sterile package



REF 461 **XL**

**TRACOE *vario* XL Tracheostomy Tube**  
 with adjustable neck flange, low pressure cuff,  
 X-ray contrast line, scale and 15 mm connector

- Including:
- ◆ obturator and neck strap
  - ◆ in sterile package

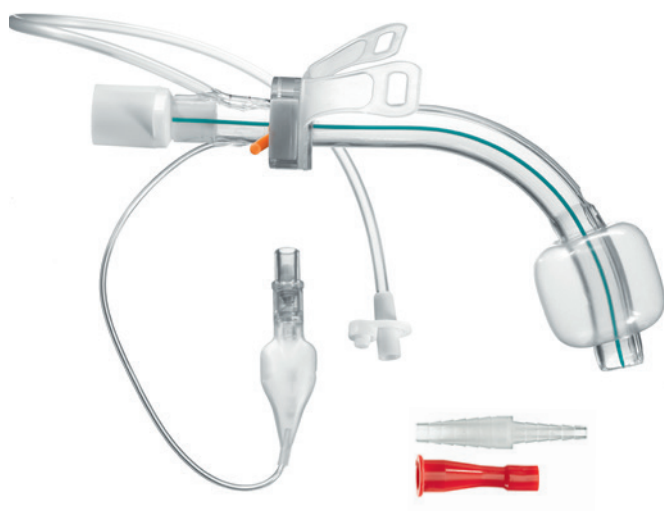

REF 471 **XL**

**TRACOE *vario* extract XL Tracheostomy Tube**  
 with adjustable neck flange, low pressure cuff,  
 subglottic suction line, X-ray contrast line, scale  
 and 15 mm connector

- Including:
- ◆ 2 connectors for suction pump
  - ◆ obturator and neck strap
  - ◆ in sterile package

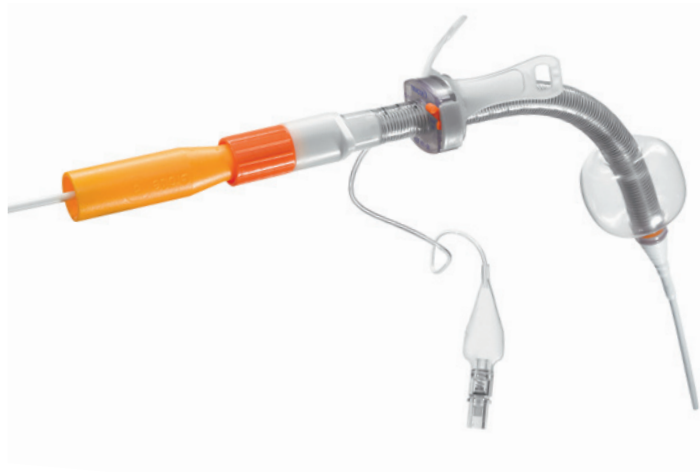

REF 451-P **XL**

**TRACOE *vario* XL Tracheostomy Tube** with minimally traumatic insertion system, spiral-reinforced, adjustable neck flange, low pressure cuff, scale and 15 mm connector

- Including:
- ◆ lubricating gel
  - ◆ obturator and neck strap
  - ◆ in sterile package

**As percutaneous set in REF 421**



REF 461-P **XL**

**TRACOE *vario* XL Tracheostomy Tube** with minimally traumatic insertion system, adjustable neck flange, low pressure cuff, X-ray contrast line, scale and 15 mm connector

- Including:
- ◆ lubricating gel
  - ◆ obturator and neck strap
  - ◆ in sterile package

**As percutaneous set in REF 424**



REF 471-P **XL**

**TRACOE *vario* extract XL Tracheostomy Tube** with minimally traumatic insertion system, adjustable neck flange, low pressure cuff, subglottic suction line, X-ray contrast line, scale and 15 mm connector

- Including:
- ◆ lubricating gel
  - ◆ 2 connectors for suction pump
  - ◆ obturator and neck strap
  - ◆ in sterile package

**As percutaneous set in REF 425**

# Technical Data

## TRACOE vario

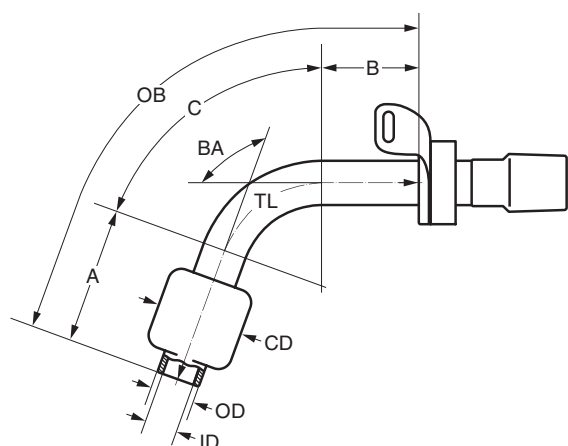

REF 450, REF 455, REF 460 *in sizes 06 – 11*  
 REF 464 *in sizes 07 – 09*  
 REF 470 *in sizes 07 – 10*  
 REF 450-P, REF 460-P *in sizes 07 – 09*  
 REF 470-P *in sizes 08 – 09*

Size	ID	OD	A	C	B	TL	OB	BA	CD
	mm	mm	mm	mm	mm	mm	mm	°	mm
06	6.0	8.2	30	28	12	70	76	100	23
07	7.0	9.7	33	32	15	80	86	100	26
08	8.0	11.2	35	35	20	90	97	100	28
09	9.0	12.3	38	35	27	100	106	100	30
10	10.0	13.7	38	37	35	110	120	100	32
11	11.0	14.8	38	37	35	110	121	100	34

## TRACOE vario XL

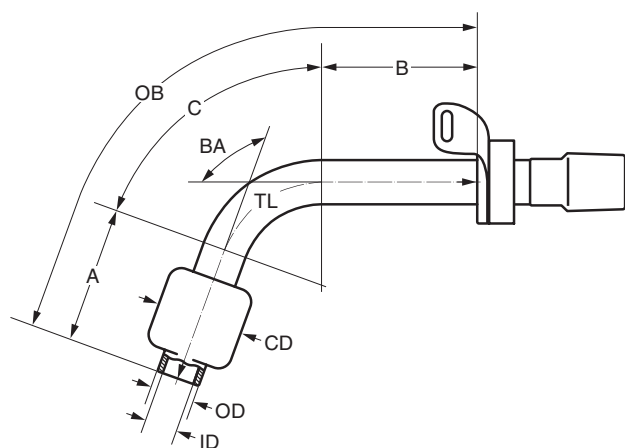

REF 451, REF 461, REF 471 *in sizes 07 – 10*  
 REF 451-P, REF 461-P *in sizes 07 – 09*  
 REF 471-P *in sizes 08 – 09*

Size	ID	OD	A	C	B	TL	OB	BA	CD
	mm	mm	mm	mm	mm	mm	mm	°	mm
07	7.0	9.7	35	36	33	104	110	100	26
08	8.0	11.2	37	43	40	123	128	100	28
09	9.0	12.3	38	43	45	126	134	100	30
10	10.0	13.7	38	52	45	135	146	100	32

**ID:** inside diameter (clear width) at bottom of cannula; **OD:** outside diameter at bottom of cannula; **A:** length; **C:** length; **B:** length; **TL:** length along centre line; **OB:** length along outer bend; **BA:** bending angle; **CD:** cuff diameter

To order, specify **REF + size**, e. g. **REF 450-08**

# Speciality and Scope of Supply

## The Subglottic Suction Line



In all TRACOE tracheostomy tubes equipped with subglottic suction lines, the opening of the line is just above the cuff. Secretions in the subglottic space can therefore be suctioned off at the lowest point of collection. This reduces the risk of bacterially contaminated secretions entering the lower respiratory tract and the risk of developing aspiration pneumonia.

The TRACOE *vario* opening is designed to minimise mucosal damage from suctioning.

## Highly Adaptable



The TRACOE *vario* tube has a patented adjustable neck flange. By means of a practical push-button mechanism, the flange can be moved along the tracheostomy tube and adjusted to the individual patient. The flange is fixed securely in position by moving the orange locking lever upwards. Since no screw closure is used, no pressure at all is exerted on the trachea.

The flexible wings of the TRACOE *vario* neck flange can be adjusted independently, providing further opportunities to accommodate the individual patient's anatomy.

## Scope of Supply of TRACOE *vario* and *vario* XL Tubes

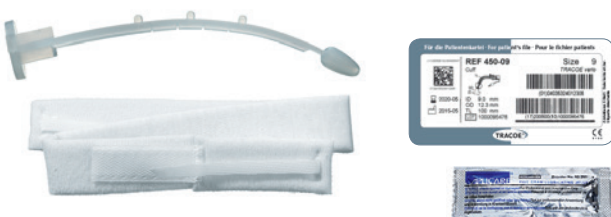

All TRACOE *vario* and *vario* XL tubes are supplied with an obturator, a wide adjustable neck strap, and a product info card with two detachable labels.

Lubricating gel is also supplied with the *vario* P-tubes.



## Ventilating – Sensitising – Communicating – Weaning – Decannulating

The TRACOE *twist* and TRACOE *twist plus* tracheostomy tubes are used as ventilation and therapy tubes with inner cannulas in hospitals, rehabilitation, and community settings.

A special feature of TRACOE *twist* tubes is the anatomically shaped neck flange that moves in both the vertical and horizontal axes. Patients can turn their heads freely, without

the tracheostomy tube exerting any strong pressure on the trachea. It is easy to attach or exchange the neck strap while the tube is in situ.

Sizing of the two product lines always corresponds to the inside diameter of the inner cannula. For example, when it says 8mm on the neck flange, the lumen of the inner cannula is 8mm.



# TRACOE®

*twist*



twist

For breathing and ventilation, the lumen should be as large as possible – that is why the internal measurement is given. For the patient, every millimetre counts. If the diameter of the lumen is reduced from 8 to 7 mm, the air supply is 41 % less and there is a huge increase in the effort required to breathe. Changing from 8 to 9 mm increases the air supply by 60 %, while the effort required to breathe remains the same.\*

Fourteen types of DEHP-free tubes in the TRACOE *twist* and *twist plus* product lines offer the wide choice needed to select the best tube for each patient. Cuffed tubes, also with subglottic suction lines, are the first choice for use in percutaneous dilatation procedures – see the TRACOE *percutan* line.

\* Hagen-Poiseuille equation on laminar flow



**REF 301**

**TRACOE *twist* Tracheostomy Tube**  
with low pressure cuff

- Including:
- ◆ 2 inner cannulas with 15mm connector
  - ◆ perforated obturator
  - ◆ neck strap
  - ◆ in sterile package



**REF 302**

**TRACOE *twist* Tracheostomy Tube**  
with low pressure cuff and fenestration

- Including:
- ◆ inner cannula, fenestrated, with 15mm connector
  - ◆ inner cannula with 15mm connector
  - ◆ occlusion cap for fenestrated tubes
  - ◆ perforated obturator
  - ◆ neck strap
  - ◆ in sterile package



**REF 303**

**TRACOE *twist* Tracheostomy Tube**

- Including:
- ◆ 2 inner cannulas with 15mm connector
  - ◆ perforated obturator
  - ◆ neck strap
  - ◆ in sterile package



## REF 301-P

### TRACOE *twist* Tracheostomy Tube

with minimally traumatic inserter and low pressure cuff

- Including:
- ◆ 2 inner cannulas with 15mm connector
  - ◆ reinsertion tube
  - ◆ lubricating gel
  - ◆ perforated obturator
  - ◆ neck strap
  - ◆ in sterile package

As percutaneous set in REF 320



## REF 302-P



### TRACOE *twist* Tracheostomy Tube

with minimally traumatic inserter, low pressure cuff and fenestration

- Including:
- ◆ inner cannula, fenestrated, with 15mm connector
  - ◆ 2 inner cannulas with 15mm connector
  - ◆ occlusion cap for fenestrated tubes
  - ◆ reinsertion tube
  - ◆ lubricating gel
  - ◆ perforated obturator
  - ◆ neck strap
  - ◆ in sterile package

As percutaneous set in REF 321



## REF 304



### TRACOE *twist* Tracheostomy Tube

with fenestration

- Including:
- ◆ inner cannula, fenestrated, with 15mm connector
  - ◆ 2 inner cannulas with 15mm connector
  - ◆ occlusion cap for fenestrated tubes
  - ◆ perforated obturator
  - ◆ neck strap
  - ◆ in sterile package





**REF 306**

**TRACOE *twist* Tracheostomy Tube**  
with low pressure cuff and subglottic suction line

- Including:
- ◆ 2 inner cannulas with 15mm connector
  - ◆ 2 connectors for suction devices
  - ◆ perforated obturator
  - ◆ neck strap
  - ◆ in sterile package



**REF 888-306**



**TRACOE *twist* Tracheostomy Tube**  
with low pressure cuff, subglottic suction line,  
and fenestration

- Including:
- ◆ inner cannula, fenestrated,  
with 15mm connector
  - ◆ inner cannula with 15mm connector
  - ◆ 2 connectors for suction devices
  - ◆ occlusion cap for fenestrated tubes
  - ◆ perforated obturator
  - ◆ neck strap
  - ◆ in sterile package



**REF 305**

**TRACOE *twist* Laryngectomy Tube**

- Including:
- ◆ inner cannula, fenestrated,  
with 15mm connector
  - ◆ inner cannula with grooved  
low profile connector
  - ◆ obturator
  - ◆ neck strap
  - ◆ in sterile package



## REF 306-P

### TRACOE *twist* Tracheostomy Tube

with minimally traumatic inserter, low pressure cuff and subglottic suction line

- Including:
- ◆ 2 inner cannulas with 15 mm connector
  - ◆ 2 connectors for suction devices
  - ◆ reinsertion tube
  - ◆ lubricating gel
  - ◆ perforated obturator
  - ◆ neck strap
  - ◆ in sterile package

As percutaneous set in REF 322



## REF 888-306-P



### TRACOE *twist* Tracheostomy Tube

with minimally traumatic inserter, low pressure cuff, subglottic suction line and fenestration

- Including:
- ◆ inner cannula, fenestrated, with 15mm connector
  - ◆ 2 inner cannulas with 15mm connector
  - ◆ occlusion cap for fenestrated tubes
  - ◆ reinsertion tube
  - ◆ lubricating gel
  - ◆ perforated obturator
  - ◆ neck strap
  - ◆ in sterile package

As percutaneous set in REF 888-322



## REF 309

### TRACOE *twist* Tracheostomy Tube

with low pressure cuff and air supply line for speaking

- Including:
- ◆ inner cannula with 15 mm connector
  - ◆ perforated obturator
  - ◆ neck strap
  - ◆ in sterile package



**REF 311** 

**TRACOE *twist plus* Tracheostomy Tube**  
with low pressure cuff

- Including:
- ◆ 2 inner cannulas with 15 mm connector
  - ◆ perforated obturator
  - ◆ neck strap
  - ◆ in sterile package



**REF 312**  

**TRACOE *twist plus* Tracheostomy Tube**  
with low pressure cuff and double fenestration  
at inner and outer bend

- Including:
- ◆ inner cannula, double fenestrated with 15 mm connector
  - ◆ inner cannula with 15 mm connector
  - ◆ occlusion cap for fenestrated tubes
  - ◆ perforated obturator
  - ◆ neck strap
  - ◆ in sterile package



**REF 313** 

**TRACOE *twist plus* Tracheostomy Tube**

- Including:
- ◆ 2 inner cannulas with 15 mm connector
  - ◆ perforated obturator
  - ◆ neck strap
  - ◆ in sterile package



**REF 311-P** 

**TRACOE *twist* plus Tracheostomy Tube**  
with minimally traumatic inserter and low pressure cuff

- Including:
- ◆ 2 inner cannulas with 15mm connector, one pre-mounted
  - ◆ lubricating gel
  - ◆ perforated obturator
  - ◆ neck strap
  - ◆ in sterile package

As percutaneous set in REF 330



**REF 312-P**  

**TRACOE *twist* plus Tracheostomy Tube**  
with minimally traumatic inserter, low pressure cuff and double fenestration at inner and outer bend

- Including:
- ◆ 2 inner cannulas with 15mm connector, one pre-mounted
  - ◆ inner cannula, double fenestrated with 15mm connector
  - ◆ occlusion cap for fenestrated tubes
  - ◆ lubricating gel
  - ◆ perforated obturator
  - ◆ neck strap
  - ◆ in sterile package

As percutaneous set in REF 331



**REF 314**  

**TRACOE *twist* plus Tracheostomy Tube**  
with double fenestration at inner and outer bend

- Including:
- ◆ inner cannula with 15mm connector
  - ◆ inner cannula, double fenestrated with 15mm connector
  - ◆ occlusion cap for fenestrated tubes
  - ◆ perforated obturator
  - ◆ neck strap
  - ◆ in sterile package



**REF 316** 

**TRACOE *twist* plus Tracheostomy Tube**  
with low pressure cuff and subglottic suction line

- Including:
- ◆ 2 inner cannulas with 15mm connector
  - ◆ 2 connectors for suction devices
  - ◆ perforated obturator
  - ◆ neck strap
  - ◆ in sterile package



**REF 888-316**  

**TRACOE *twist* plus Tracheostomy Tube**  
with low pressure cuff, subglottic suction line and  
double fenestration at inner and outer bend

- Including:
- ◆ inner cannula with 15mm connector
  - ◆ inner cannula, double fenestrated with 15mm connector
  - ◆ 2 connectors for suction devices
  - ◆ occlusion cap for fenestrated tubes
  - ◆ perforated obturator
  - ◆ neck strap
  - ◆ in sterile package





**REF 316-P** 

**TRACOE *twist* plus Tracheostomy Tube**  
with minimally traumatic inserter, low pressure cuff  
and subglottic suction line

- Including:
- ◆ 2 inner cannulas with 15 mm connector, one pre-mounted
  - ◆ 2 connectors for suction devices
  - ◆ lubricating gel
  - ◆ perforated obturator
  - ◆ neck strap
  - ◆ in sterile package

As percutaneous set in REF 332

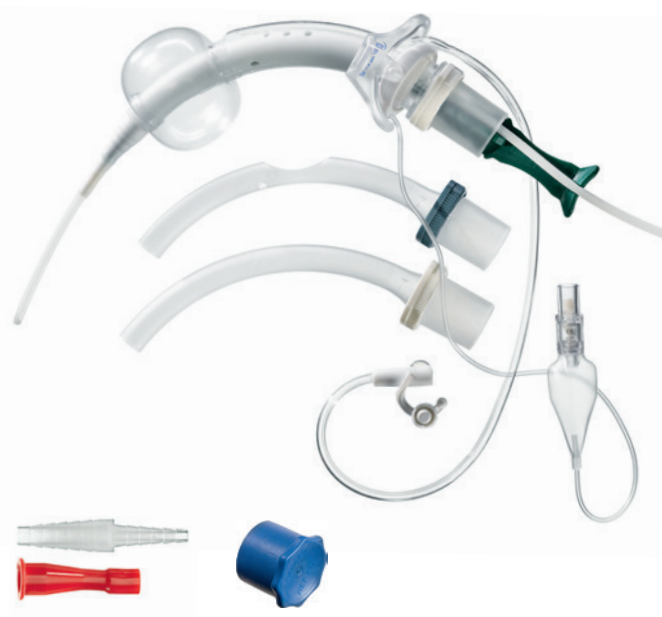

**REF 888-316-P**  

**TRACOE *twist* plus Tracheostomy Tube**  
with minimally traumatic inserter, low pressure cuff,  
subglottic suction line and double fenestration at inner  
and outer bend

- Including:
- ◆ 2 inner cannulas with 15 mm connector, one pre-mounted
  - ◆ inner cannula, double fenestrated with 15 mm connector
  - ◆ 2 connectors for suction devices
  - ◆ lubricating gel
  - ◆ perforated obturator
  - ◆ neck strap
  - ◆ in sterile package

As percutaneous set in REF 888-332



**REF 501**

**TRACOE *twist* Spare Inner Cannulas**  
with 15 mm connector

- Packaging unit:
- ◆ 3 units (*in sizes 04 – 10*)
  - ◆ 10 units under **REF 501-X** (*in sizes 04 – 10*)
  - ◆ 30 units under **REF 501-XXX** (*in sizes 06 – 09*)
  - ◆ sterile, individually packaged



**REF 506**



**TRACOE *twist* Spare Inner Cannulas**  
fenestrated, with 15 mm connector

- Packaging unit:
- ◆ 3 units (*in sizes 04 – 10*)
  - ◆ 10 units under **REF 506-X** (*in sizes 04 – 10*)
  - ◆ sterile, individually packaged



**REF 401**



**TRACOE *twist* Inner Cannulas**  
fenestrated, with integrated speaking valve

- Packaging unit:
- ◆ 2 units (*in sizes 04 – 10*)
  - ◆ sterile, individually packaged



**REF 503**

**TRACOE *twist* Spare Inner Cannulas**  
short, with 15 mm connector, for REF 305

- Packaging unit:
- ◆ 3 units (*in sizes 05 – 10*)
  - ◆ sterile, individually packaged



**REF 521**

**TRACOE *twist* plus Spare Inner Cannulas**  
with 15 mm connector

- Packaging unit:
- ◆ 3 units (*in sizes 07 – 10*)
  - ◆ 10 units under **REF 521-X**  
(*in sizes 07 – 10*)
  - ◆ 30 units under **REF 521-XXX**  
(*in sizes 07 – 09*)
  - ◆ sterile, individually packaged



**REF 523**



**TRACOE *twist* plus Spare Inner Cannulas**  
double fenestrated, with 15 mm connector

- Packaging unit:
- ◆ 3 units (*in sizes 07 – 10*)
  - ◆ 10 units under **REF 523-X**  
(*in sizes 07 – 10*)
  - ◆ sterile, individually packaged

# Technical Data

## TRACOE *twist*

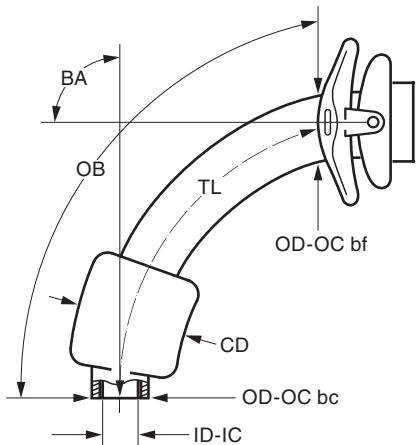

REF 301, REF 302, REF 303,  
REF 304, REF 306, REF 309

*in sizes 04 – 10*

REF 888-306

*in sizes 06 – 10*

REF 301-P, REF 302-P,  
REF 306-P, REF 888-306-P

*in sizes 07 – 09*

Size	ID-IC mm	OD-OC bc mm	OD-OC bf mm	TL mm	OB mm	BA e°	CD mm
04	4.0	7.2	8.6	59	63.0	110	15
05	5.0	8.6	10.1	66	73.0	100	18
06	6.3	9.2	10.8	72	79.5	95	23
07	7.3	10.4	12.0	74	80.5	95	26
08	8.0	11.4	12.7	76	83.0	90	28
09	9.0	12.5	14.2	78	88.5	90	30
10	10.0	13.8	15.2	80	89.5	90	32

## TRACOE *twist* Laryngectomy Tube

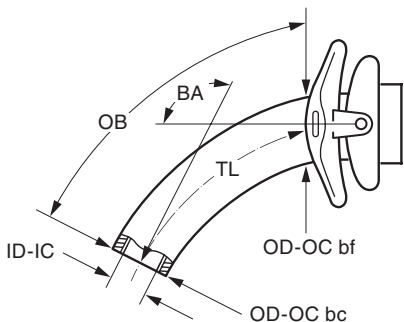

REF 305

Size	ID-IC mm	OD-OC bc mm	OD-OC bf mm	TL mm	OB mm	BA e°
05	5.2	9.0	10.1	47	52	125
06	6.4	9.4	10.8	50	56	120
07	7.4	10.6	12.0	52	59	120
08	8.0	11.6	12.7	56	63	115
09	9.0	12.8	14.2	58	66	108
10	10.0	14.2	15.2	60	70	100

**ID-IC:** inside diameter (clear width) at bottom of inner cannula; **OD-OC bc:** outside diameter at bottom of outer cannula; **OD-OC bf:** outside diameter of outer cannula behind the flange; **TL:** along centre line from start of neck flange to bottom of tube; **OB:** length along outer bend from start of neck flange to bottom of tube; **BA:** bending angle; **CD:** Cuffdiameter

To order, specify: **REF + Size**, e.g. **REF 306-08**

# Technical Data and Scope of Supply

## TRACOE *twist plus*

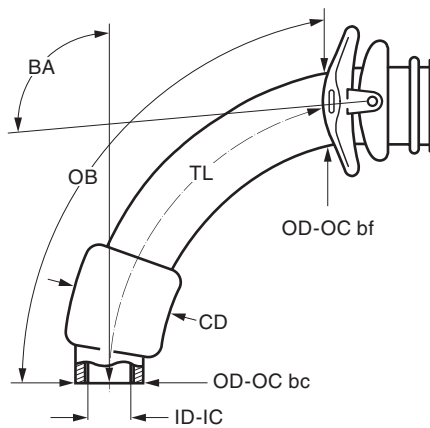

REF 311, REF 312, REF 313, REF 314, REF 316, REF 888-316,  
REF 311-P, REF 312-P, REF 316-P, REF 888-316-P

Size	ID-IC	OD-OC bc	OD-OC bf	TL	OB	BA	CD
	mm	mm	mm	mm	mm	°	mm
07	7.0	9.8	10.1	85	91	100	26
08	8.0	10.8	11.1	88	95	100	28
09	9.0	11.8	12.1	90	99	100	30
10	10.0	12.8	13.1	92	102	100	32

## Scope of Supply of TRACOE *twist* and *twist plus* Tubes



*twist*



*twist plus*



All TRACOE *twist* and *twist plus* tracheostomy tubes are supplied with a perforated obturator (in sizes 06 – 10), a wide adjustable neck strap, and a product info card with two detachable labels.



Lubricating gel is supplied with the TRACOE *twist* and *twist plus* P-tubes.



All TRACOE *twist* P-tubes come with a reinsertion tube.

# Product Information and Specialities

## Fenestration



### TRACOE *twist* and *twist plus*

Fenestrated *twist* and *twist plus* tubes have perforations on the outer bend. The *twist plus* tube has double fenestration with additional phonation holes on the inner bend (tube length is adjusted according to the patient's increasing body mass index (BMI)).

### TRACOE *twist* REF 888-306 and *twist plus* REF 888-316

Multifunctional tracheostomy tubes with cuff, subglottic suction line, and speaking function. Can be used with closed inner cannula for ventilation or with fenestrated inner cannula and deflated cuff as a therapy tube.

## Features of the Inner and Outer Cannulas

### Green and White mean non-fenestrated



- ◆ Green lettering on the neck flange indicates a non-fenestrated outer cannula



- ◆ Non-fenestrated TRACOE *twist* inner cannulas are identified by white 15mm connectors



- ◆ Non-fenestrated TRACOE *twist plus* inner cannulas are identified by a white grooved low-profile connector

### Blue means fenestrated



- ◆ Blue lettering on the neck flange indicates a fenestrated outer cannula



- ◆ Fenestrated TRACOE *twist* inner cannulas are identified by blue 15mm connectors



- ◆ Fenestrated TRACOE *twist plus* inner cannulas are identified by a blue grooved low-profile connector



A video with detailed tips for the care of the TRACOE *twist* and *twist plus* tubes you can find on our website [www.tracoe.com/en/media-library](http://www.tracoe.com/en/media-library)

## It's the Inner Values that count!



View of tube end

For the patient, every millimetre counts. If the diameter of the lumen is reduced from 8 to 7 mm, the air supply is 41 % less and there is a huge increase in the effort required to breathe. Changing from 8 to 9 mm increases the air supply by 60 %, while the effort required to breathe remains the same.

Sizing of the TRACOE *twist* and *twist plus* lines always corresponds to the inside diameter of the inner cannula. For example, when it says 8 mm on the neck flange, the lumen of the inner cannula is 8 mm. Placing the inner cannula in the outer cannula does not reduce the lumen available to the patient for breathing or ventilation.

## Subglottic Suction Line



Accumulated secretions in the subglottic space can be suctioned off at the lowest point, i.e. just above the cuff. This reduces the risk of bacterially contaminated secretions entering the lower respiratory tract and the risk of developing aspiration pneumonia.

In the TRACOE *twist* and *twist plus* tubes, the opening of the subglottic suction line is at the lowest point, just above the cuff. Because the tube wall is not very thick, the line runs on the tube and not within the wall. Funnel and cone connectors are supplied to connect the suction lines.

The TRACOE *twist* and *twist plus* multifunctional tubes REF 888-306 and REF 888-316 for ventilation, subglottic suction, and communication offer patients who need a cuffed tube to prevent aspiration the possibility of speaking.

## Air Supply for Speaking



### TRACOE *twist* REF 309

This tube allows the patient to speak when ventilated. The air supply line has two additional holes and with the help of the fingertip, the airflow can be manually regulated to control the formation of voices.



## The Smaller the Detail, the Greater the Value

The true size can be particularly important in children. Our new TRACOE *kids* product range consists of the tried and trusted TRACOE mini and the brand-new TRACOE silcosoft. The tracheostomy tubes in both these lines have been developed especially for neonates, infants and older children. We have focussed particularly on the flange design and the use of comfortable materials.

NEW! TRACOE silcosoft: very soft, flexible, spiral-reinforced silicone tubes, with and without cuff. Special features include the optimal shape of the flange and the patented, especially reinforced eyelets.

Our tried and trusted TRACOE mini is a soft, thin-walled but stable PVC tube that does not contain DEHP. The flange has a sloping undersurface to optimise the fit.



# TRACOE®

*kids*



*kids*

## Light and Safe

The specially designed obturator is extremely practical. The ring-shaped grip ensures that tubes can be inserted safely and easily, despite their small size and different materials. Extensions, neck straps, heat/moisture exchangers, and special compresses are available to fit the TRACOE *kids* tubes.

## Anatomically Optimised Solutions

To ensure the best solution for each young patient, TRACOE mini is available in 12 different sizes: 4 for use in neonates/infants and 8 for pediatric use. TRACOE silcosoft is available in 11 different sizes: 4 for use in neonates/infants and 7 for pediatric use.

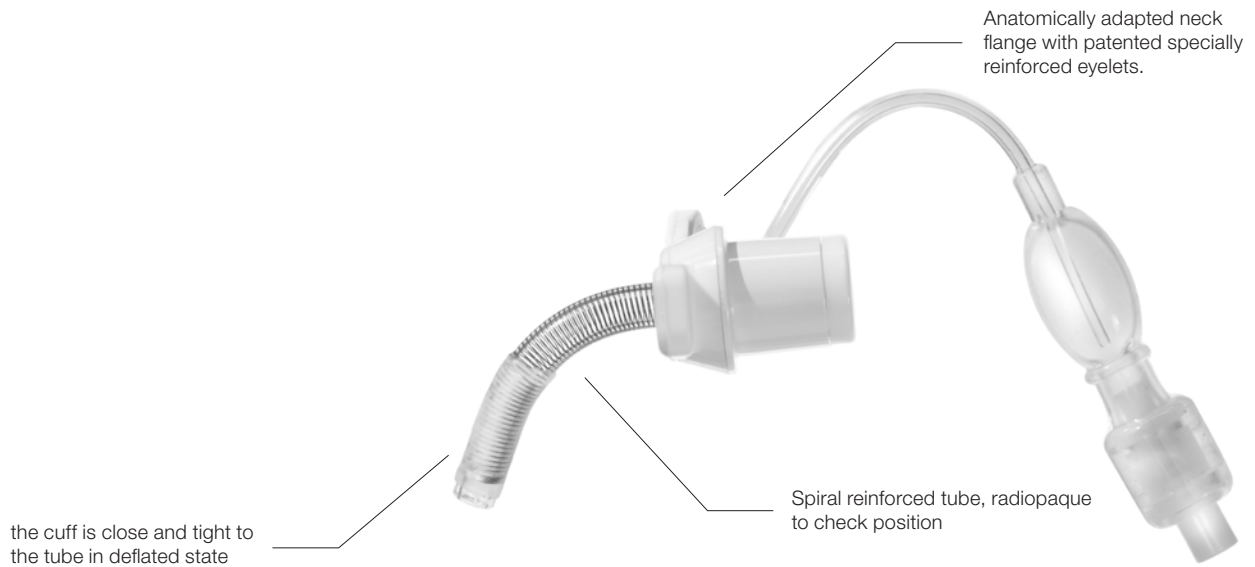

## Special Features

TRACOE silcosoft is a very soft, flexible, spiral-reinforced silicone tube. The neck flange has been designed with pediatric anatomy in mind. Patented reinforced eyelets on the flange prevent the material tearing with a hook-and-loop fastener. Length-specific variants can be supplied from stock. For larger order quantities delivery time on request.

## The H<sub>2</sub>O Cuff

When the cuff is deflated, it is close and tight to the tube. It is filled with up to 2 ml of sterile water. The cuff acts as a seal to prevent the aspiration of food and saliva from the pharynx and the unwanted escape of air during ventilation.

## The 'Silicone Advantage'

The material properties of silicone are particularly beneficial to young patients: well tolerated, free from latex and DEHP, and easy to insert. It is less likely to become encrusted and is easy to clean. TRACOE silcosoft tubes can be re-used up to 7 times.

## Obturator with ring-shaped grip

The specially designed obturator is extremely practical. The ring-shaped grip ensures that the tube can be inserted safely and easily, despite its small size.



More information in our product video  
on our website [www.tracoe.com/en/media-library](http://www.tracoe.com/en/media-library)



REF 360  

**TRACOE silcosoft® Tracheostomy Tube**  
for neonates and infants, made from silicone

- Including:
- ◆ ring obturator
  - ◆ neck strap
  - ◆ disconnection wedge
  - ◆ in sterile package



REF 361  

**TRACOE silcosoft® PL Tracheostomy Tube**  
for neonates and infants, proximal longer,  
made from silicone

- Including:
- ◆ obturator
  - ◆ neck strap
  - ◆ disconnection wedge
  - ◆ in sterile package



REF 362  

**TRACOE silcosoft® Tracheostomy Tube**  
for neonates and infants, with H<sub>2</sub>O cuff,  
made from silicone

- Including:
- ◆ ring obturator
  - ◆ neck strap
  - ◆ disconnection wedge
  - ◆ in sterile package



REF 363  

**TRACOE silcosoft® PL Tracheostomy Tube**  
for neonates and infants, with H<sub>2</sub>O cuff,  
proximal longer, made from silicone

- Including:
- ◆ obturator
  - ◆ neck strap
  - ◆ disconnection wedge
  - ◆ in sterile package



REF 370



**TRACOE silcosoft® Tracheostomy Tube**  
for children, made from silicone

- Including:
- ◆ ring obturator
  - ◆ neck strap
  - ◆ disconnection wedge
  - ◆ in sterile package



REF 371



**TRACOE silcosoft® PL Tracheostomy Tube**  
for children, proximal longer, made from silicone

- Including:
- ◆ obturator
  - ◆ neck strap
  - ◆ disconnection wedge
  - ◆ in sterile package



REF 372



**TRACOE silcosoft® Tracheostomy Tube**  
for children, with H<sub>2</sub>O cuff, made from silicone

- Including:
- ◆ ring obturator
  - ◆ neck strap
  - ◆ disconnection wedge
  - ◆ in sterile package

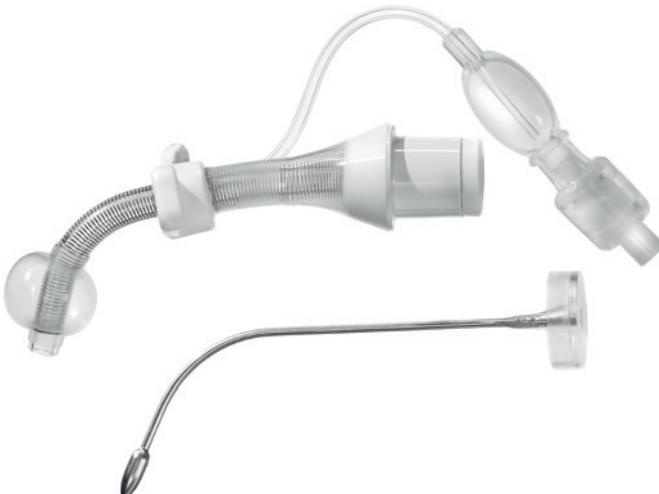

REF 373



**TRACOE silcosoft® PL Tracheostomy Tube**  
for children, with H<sub>2</sub>O cuff, proximal longer,  
made from silicone

- Including:
- ◆ obturator
  - ◆ neck strap
  - ◆ disconnection wedge
  - ◆ in sterile package



REF 350



**TRACOE mini Tracheostomy Tube**  
for neonates and infants

- Including:
- ◆ ring obturator
  - ◆ neck strap
  - ◆ in sterile package



REF 355



**TRACOE mini Tracheostomy Tube**  
for children

- Including:
- ◆ ring obturator
  - ◆ neck strap
  - ◆ in sterile package



REF 356

**TRACOE kids Extension Piece**

- Including:
- ◆ disconnection wedge
  - ◆ in sterile package

Prevents obstruction of the patient end of the tube. The dead space will be increased by approx. 3.5 – 4 ml (cm<sup>3</sup>), which corresponds to the normal dead space of 2 – 3 years old children. Fits all mini tubes up to an inner diameter of 6 mm. While using a proximal longer tube for children please be aware of the increased dead space.

# Technical Data and Scope of Supply

## TRACOE silcosoft® for Neonates and Infants

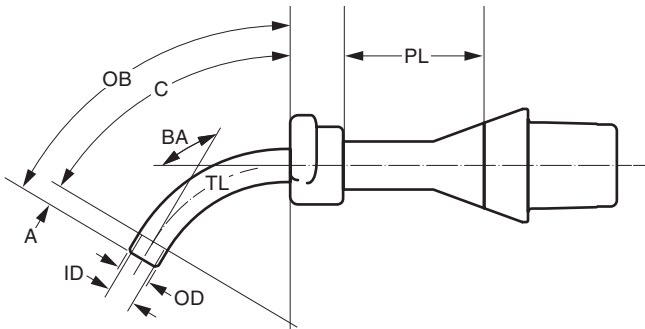

REF 360, REF 361, REF 362, REF 363

Size	ID	OD	A	C	TL	OB	BA	PL
	mm	mm	mm	mm	mm	mm	°	mm
2.5	2.5	4.4	3.2	26.8	30	32	120	15
3.0	3.0	4.9	4.0	28.0	32	34	120	17
3.5	3.5	5.4	5.0	29.0	34	37	120	20
4.0	4.0	6.0	7.0	29.0	36	39	120	22

## TRACOE silcosoft® for Children

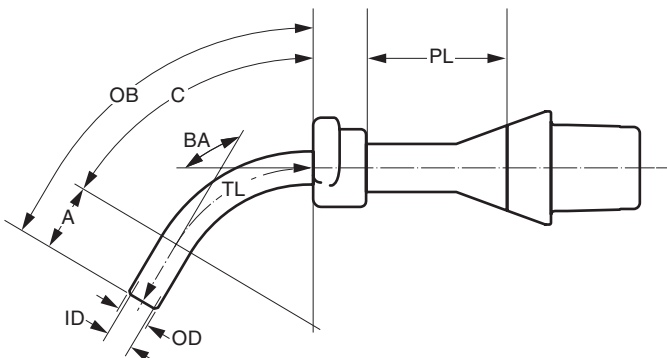

REF 370, REF 371, REF 372, REF 373

Size	ID	OD	A	C	TL	OB	BA	PL
	mm	mm	mm	mm	mm	mm	°	mm
2.5	2.5	4.4	9	29.0	38	40	120	20
3.0	3.0	4.9	10	29.0	39	41	120	20
3.5	3.5	5.4	11	29.0	40	43	120	25
4.0	4.0	6.0	12	29.0	41	44	120	25
4.5	4.5	6.6	13	29.0	42	45	120	30
5.0	5.0	7.3	15	29.0	44	48	120	30
5.5	5.5	8.4	17	29.0	46	50	120	30

**ID:** inside diameter (clear width) of tube; **OD:** outside diameter of tube; **A:** length; **C:** length; **B:** length; **TL:** length along centre line from start of neck flange to bottom of tube; **OB:** length along outer bend from start of neck flange to bottom of tube; **BA:** bending angle **PL:** proximal longer

To order, specify **REF + size**, e. g. **REF 370-2.5**



Product variants can be made in order to optimise the functionality and wearing comfort and also for patients with complex anatomical and physiological conditions. The order form is available on our website [www.tracoe.com/en/downloads](http://www.tracoe.com/en/downloads).

## Scope of Supply of TRACOE kids Tubes



All TRACOE *kids* tubes are supplied with an obturator, a soft wide adjustable neck strap (REF 903-G), and a product info card with two detachable labels.



All TRACOE silcosoft tubes are supplied with a disconnection wedge.

# Technical Data and Specialities

## TRACOE mini for Neonates and Infants

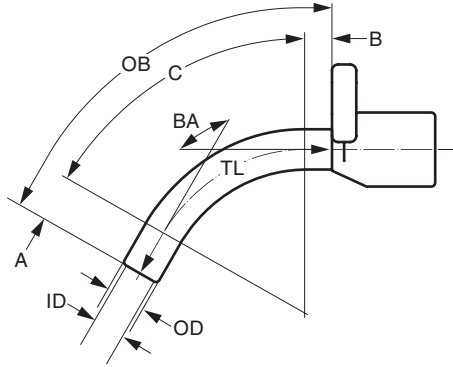

REF 350

Size	ID	OD	A	C	B	TL	OB	BA
	mm	mm	mm	mm	mm	mm	mm	°
2.5	2.5	3.6	6	22	2	30	32	120
3.0	3.0	4.3	7	23	2	32	34	120
3.5	3.5	5.0	8	23	3	34	37	120
4.0	4.0	5.6	9	24	3	36	40	120

## TRACOE mini for Children

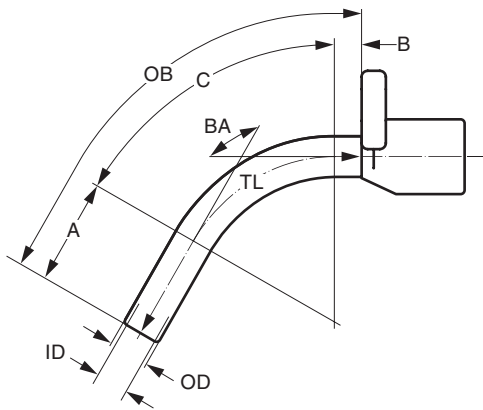

REF 355

Size	ID	OD	A	C	B	TL	OB	BA
	mm	mm	mm	mm	mm	mm	mm	°
2.5	2.5	3.6	8	22	2	32	34	120
3.0	3.0	4.3	10	24	2	36	39	120
3.5	3.5	5.0	12	25	3	40	43	120
4.0	4.0	5.6	14	27	3	44	48	120
4.5	4.5	6.3	16	28	4	48	52	120
5.0	5.0	7.0	18	28	4	50	55	120
5.5	5.5	7.6	20	30	5	55	60	120
6.0	6.0	8.4	22	35	5	62	67	120

## TRACOE kids Extension Piece

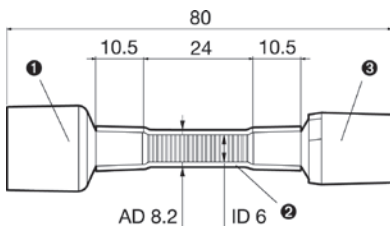

REF 356

- ❶ 15 mm connector, female;
- ❷ reinforced tube;
- ❸ 15 mm connector, male



REF 643



**TRACOE humid assist kids Heat & Moisture Exchanger, HME with paper filter**, for attachment to any pediatric tube with 15 mm connector, to be used in children with tidal volume of 7 to 50 ml

Details of the product are given in the modular product line on page 85.



## Superb Quality

TRACOE *comfort*: The extremely comfortable long-term tubes have traditionally been hand-crafted for the past six decades. They are characterised by their softness and flexibility and are particularly economical to use thanks to their durability.

## Lightweight, Soft and Flexible

TRACOE *comfort* tracheostomy tubes are made of clear polymer material (DEHP-free), which makes them both especially soft and very lightweight. They do not have to be removed for X-ray or cobalt therapy. A TRACOE *comfort* tube weighs only about one-third of a conventional silver tube of the same size. Because they are transparent, it is also very easy to ensure that they are perfectly clean.





## **As Comfortable as Possible**

As the name suggests, TRACOE *comfort* tubes are designed to be as comfortable as possible for permanent wearers after tracheostomy or laryngectomy. Their discreet appearance is an added benefit. To ensure optimum quality, they are still made by hand – an extra effort that does a world of good to the patient.

## **Many Models and Sizes**

All tube types are available in many different sizes and designs. This variety facilitates the selection of the tube suitable for the respective anatomy of the patient. Also available as TRACOE *comfort plus* with a different bending angle and double fenestration. The tube length of *comfort plus* is between standard and extra-long.



**REF 101**

**TRACOE *comfort* Tracheostomy Tube**

Including: ♦ neck strap



**REF 102**

**TRACOE *comfort* Tracheostomy Tube**

Including: ♦ inner cannula with low profile  
♦ neck strap



**REF 102-D**

**TRACOE *comfort* Tracheostomy Tube**

Including: ♦ 2 inner cannulas with low profile  
♦ neck strap



**REF 106-D**

**TRACOE *comfort* Laryngectomy Tube**

Including: ♦ 2 inner cannulas with low profile  
♦ neck strap

For patients whose larynx has been removed.





**REF 201 | XL**

**TRACOE *comfort* XL Tracheostomy Tube**

Including: ♦ neck strap



**REF 202 | XL**

**TRACOE *comfort* XL Tracheostomy Tube**

Including: ♦ inner cannula with low profile  
♦ neck strap

For permanent wearers and patients with tracheal stenosis.



**REF 202-D | XL**

**TRACOE *comfort* XL Tracheostomy Tube**

Including: ♦ 2 inner cannulas with low profile  
♦ neck strap

For permanent wearers and patients with tracheal stenosis.



**REF 103** 

**TRACOE *comfort* Tracheostomy Tube**  
fenestrated

- Including:
- ◆ inner cannula, fenestrated, with slide-on speaking valve type A (silver valve holder)
  - ◆ inner cannula with low profile
  - ◆ neck strap

For tracheostomised patients with fully or partially intact larynx, for speaking.



**REF 103-O** 

**TRACOE *comfort* Tracheostomy Tube**  
fenestrated with oxygen supply port attached to the inner cannula

- Including:
- ◆ inner cannula, fenestrated, with slide-on speaking valve type A (silver valve holder) and oxygen supply port
  - ◆ inner cannula with low profile
  - ◆ neck strap

For tracheostomised patients with fully or partially intact larynx, for speaking. Made upon order.



**REF 103-A** 

**TRACOE *comfort* Tracheostomy Tube**  
fenestrated

- Including:
- ◆ inner cannula, fenestrated, with slide-on speaking valve type A (silver valve holder)
  - ◆ inner cannula with 15mm connector
  - ◆ inner cannula with low profile
  - ◆ neck strap

For tracheostomised patients with fully or partially intact larynx, for speaking.

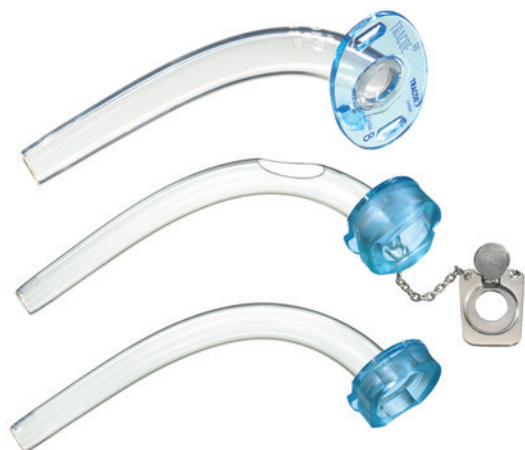
**REF 203** **XL** 
**TRACOE *comfort* XL Tracheostomy Tube**  
 fenestrated

Including: ♦ inner cannula, fenestrated, with slide-on speaking valve type A (silver valve holder)  
 ♦ inner cannula with low profile  
 ♦ neck strap

For tracheostomised patients with fully or partially intact larynx for speaking or e. g. with tracheal stenosis.

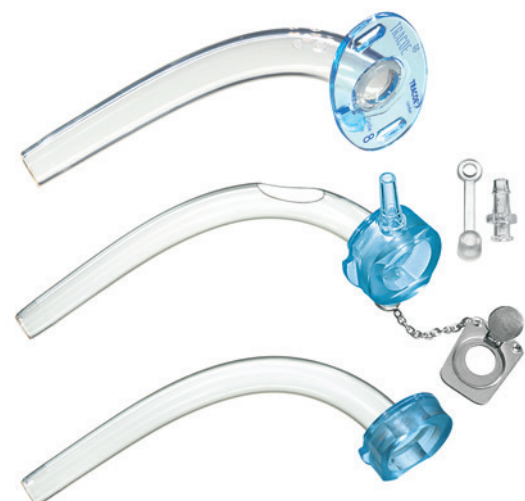
**REF 203-O** **XL** 
**TRACOE *comfort* XL Tracheostomy Tube**  
 fenestrated with oxygen supply port attached to the inner cannula

Including: ♦ inner cannula, fenestrated, with slide-on speaking valve type A (silver valve holder) and oxygen supply port  
 ♦ inner cannula with low profile  
 ♦ neck strap

For tracheostomised patients with fully or partially intact larynx for speaking or e. g. with tracheal stenosis. Made upon order.

**REF 203-A** **XL** 
**TRACOE *comfort* XL Tracheostomy Tube**  
 fenestrated

Including: ♦ inner cannula, fenestrated, with slide-on speaking valve type A (silver valve holder)  
 ♦ inner cannula with 15mm connector  
 ♦ inner cannula with low profile  
 ♦ neck strap

For tracheostomised patients with fully or partially intact larynx for speaking or e. g. with tracheal stenosis.



**REF 103-A-O** 

**TRACOE *comfort* Tracheostomy Tube**  
fenestrated with oxygen supply port attached to the inner cannula

- Including:
- ◆ inner cannula, fenestrated, with slide-on speaking valve type A (silver valve holder) and oxygen supply port
  - ◆ inner cannula with 15mm connector
  - ◆ inner cannula with low profile
  - ◆ neck strap

For tracheostomised patients with fully or partially intact larynx, for speaking. Made upon order.



**REF 104** 

**TRACOE *comfort* Tracheostomy Tube**  
fenestrated

- Including:
- ◆ inner cannula, fenestrated, with swivel speaking valve type B
  - ◆ inner cannula with low profile
  - ◆ neck strap

For tracheostomised patients with fully or partially intact larynx, for speaking.



**REF 104-O** 

**TRACOE *comfort* Tracheostomy Tube**  
fenestrated with oxygen supply port attached to the inner cannula

- Including:
- ◆ inner cannula, fenestrated, with swivel speaking valve type B and oxygen supply port
  - ◆ inner cannula with low profile
  - ◆ neck strap

For tracheostomised patients with fully or partially intact larynx, for speaking. Made upon order.

**REF 204** **XL** 
**TRACOE *comfort* XL Tracheostomy Tube**  
 fenestrated

Including: ♦ inner cannula, fenestrated, with swivel speaking valve type B  
 ♦ inner cannula with low profile  
 ♦ neck strap

For tracheostomised patients with fully or partially intact larynx for speaking or e. g. with tracheal stenosis.

**REF 204-O** **XL** 
**TRACOE *comfort* XL Tracheostomy Tube**  
 fenestrated with oxygen supply port attached to the inner cannula

Including: ♦ inner cannula, fenestrated, with swivel speaking valve type B and oxygen supply port  
 ♦ inner cannula with low profile  
 ♦ neck strap

For tracheostomised patients with fully or partially intact larynx for speaking or e. g. with tracheal stenosis.  
 Made upon order.



REF 104-A



**TRACOE *comfort* Tracheostomy Tube**  
fenestrated

- Including:
- ◆ inner cannula, fenestrated, with swivel speaking valve type B
  - ◆ inner cannula with 15mm connector
  - ◆ inner cannula with low profile
  - ◆ neck strap

For tracheostomised patients with fully or partially intact larynx, for speaking.



REF 104-A-O



**TRACOE *comfort* Tracheostomy Tube**  
fenestrated with oxygen supply port attached to the inner cannula

- Including:
- ◆ inner cannula, fenestrated, with swivel speaking valve type B and oxygen supply port
  - ◆ inner cannula with 15mm connector
  - ◆ inner cannula with low profile
  - ◆ neck strap

For tracheostomised patients with fully or partially intact larynx, for speaking. Made upon order.



**REF 204-A** | **XL** 
**TRACOE *comfort* XL Tracheostomy Tube**  
 fenestrated

- Including:
- ◆ inner cannula, fenestrated, with swivel speaking valve type B
  - ◆ inner cannula with 15mm connector
  - ◆ inner cannula with low profile
  - ◆ neck strap

For tracheostomised patients with fully or partially intact larynx for speaking or e. g. with tracheal stenosis.

**REF 204-A-O** | **XL** 
**TRACOE *comfort* XL Tracheostomy Tube**  
 fenestrated with oxygen supply port attached to the inner cannula

- Including:
- ◆ inner cannula, fenestrated, with swivel speaking valve type B and oxygen supply port
  - ◆ inner cannula with 15mm connector
  - ◆ inner cannula with low profile
  - ◆ neck strap

For tracheostomised patients with fully or partially intact larynx for speaking or e. g. with tracheal stenosis.  
 Made upon order.



**REF 105**

**TRACOE *comfort* Tracheostomy Tube**

- Including:
- ◆ inner cannula with 15mm connector
  - ◆ neck strap



**REF 105-D**

**TRACOE *comfort* Tracheostomy Tube**

- Including:
- ◆ 2 inner cannulas with 15mm connector
  - ◆ neck strap



**REF 115**



**TRACOE *comfort* Tracheostomy Tube  
fenestrated**

- Including:
- ◆ inner cannula, fenestrated, with 15mm connector
  - ◆ inner cannula with 15mm connector
  - ◆ neck strap



**REF 205** | **XL**

**TRACOE *comfort* XL Tracheostomy Tube**

- Including:
- ◆ inner cannula with 15 mm connector
  - ◆ neck strap



**REF 215** | **XL** 

**TRACOE *comfort* XL Tracheostomy Tube fenestrated**

- Including:
- ◆ inner cannula, fenestrated, with 15 mm connector
  - ◆ inner cannula with 15 mm connector
  - ◆ neck strap



**REF 107**



**TRACOE *comfort* Tracheostomy Tube**  
fenestrated

- Including:
- ◆ inner cannula, fenestrated, with 22mm housing
  - ◆ inner cannula with 15 mm connector
  - ◆ neck strap



**REF 108**



**TRACOE *comfort* Tracheostomy Tube**  
fenestrated

- Including:
- ◆ inner cannula, fenestrated, with swivel speaking valve type B
  - ◆ inner cannula, fenestrated, with 22mm housing
  - ◆ neck strap

For tracheostomised patients with fully or partially intact larynx, for speaking.



**REF 114**



**TRACOE *comfort* Tracheostomy Tube**  
fenestrated

- Including:
- ◆ inner cannula, fenestrated, with swivel speaking valve type B
  - ◆ inner cannula with 15 mm connector
  - ◆ neck strap

For tracheostomised patients with fully or partially intact larynx, for speaking.

**REF 157**  
**TRACOE *comfort plus* Tracheostomy Tube**  
 double fenestrated at inner and outer bend

 Including: ♦ inner cannula, double fenestrated, with 22mm housing  
 ♦ inner cannula with 15mm connector  
 ♦ neck strap

**REF 158**  
**TRACOE *comfort plus* Tracheostomy Tube**  
 double fenestrated at inner and outer bend

 Including: ♦ inner cannula, double fenestrated, with swivel speaking valve type B  
 ♦ inner cannula, double fenestrated, with 22mm housing  
 ♦ neck strap

For tracheostomised patients with fully or partially intact larynx, for speaking.

**REF 164**  
**TRACOE *comfort plus* Tracheostomy Tube**  
 double fenestrated at inner and outer bend

 Including: ♦ inner cannula, double fenestrated, with swivel speaking valve type B  
 ♦ inner cannula with 15mm connector  
 ♦ neck strap

For tracheostomised patients with fully or partially intact larynx, for speaking.

# Technical Data

## TRACOE *comfort*

REF 101, REF 102, REF 102-D, REF 103, REF 103-O, REF 103-A, REF 103-A-O, REF 104, REF 104-O, REF 104-A, REF 104-A-O, REF 105, REF 105-D, REF 107, REF 108

REF 114 and REF 115 *in sizes 07 – 11*

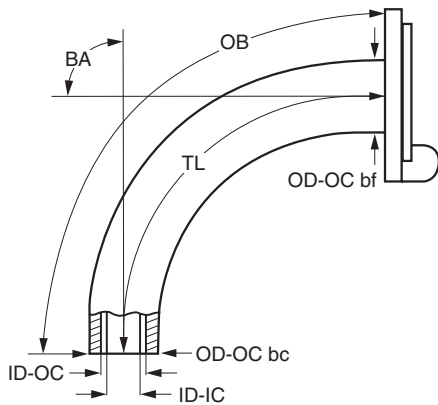

Size	ID-OC mm	OD-OC bc mm	OD-OC bf mm	ID-IC mm	TL mm	OB mm	BA °
03	3.5	4.8	6.4	2.6	42	46	90°
04	4.0	5.6	7.3	3.2	50	55	90°
05	5.0	6.7	8.7	4.0	52	57	90°
06	6.0	7.6	10.0	4.8	54	60	90°
07	7.0	8.8	10.5	5.8	57	65	90°
08	8.0	10.0	11.3	6.8	61	70	90°
09	9.0	11.4	12.6	7.6	65	75	90°
10	10.0	12.4	13.7	8.7	74	85	90°
11	11.0	13.1	15.0	9.7	76	87	90°
12	12.0	14.2	16.2	10.8	78	90	90°
13	13.0	15.4	17.2	11.8	87	100	90°
14	14.0	16.6	18.2	12.6	91	105	90°

## TRACOE *comfort* Laryngectomy Tube

REF 106-D

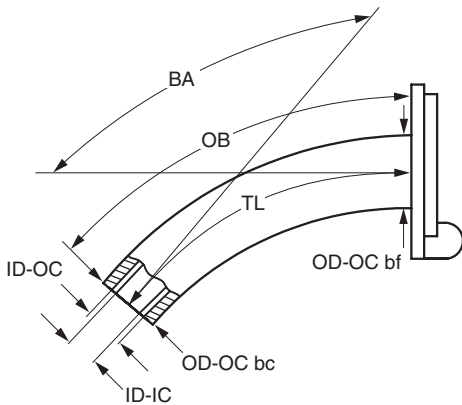

Size	ID-OC mm	OD-OC bc mm	OD-OC bf mm	ID-IC mm	TL mm	OB mm	BA °
07	7.0	8.8	10.5	5.8	47	50	130°
08	8.0	10.0	11.3	6.8	50	53	130°
09	9.0	11.4	12.6	7.6	52	57	130°
10	10.0	12.4	13.7	8.7	55	60	130°
11	11.0	13.1	15.0	9.7	58	63	130°
12	12.0	14.2	16.2	10.8	60	66	130°

**ID-OC:** inside diameter (clear width) at bottom of outer cannula; **OD-OC bc:** outside diameter at bottom of outer cannula; **OD-OC bf:** outside diameter of outer cannula behind the flange; **ID-IC:** inside diameter at bottom of inner cannula; **TL:** length along centre line from start of neck flange to bottom of tube; **OB:** length along outer bend (greatest length); **BA:** bending angle

To order, specify **REF + size**, e.g. **REF 103-08**



Product variants can be made in order to optimise the functionality and wearing comfort and also for patients with complex anatomical and physiological conditions. The relevant ordering forms are available at [www.tracoe.com/en/downloads](http://www.tracoe.com/en/downloads).

# Technical Data and Scope of Supply

## TRACOE *comfort* XL

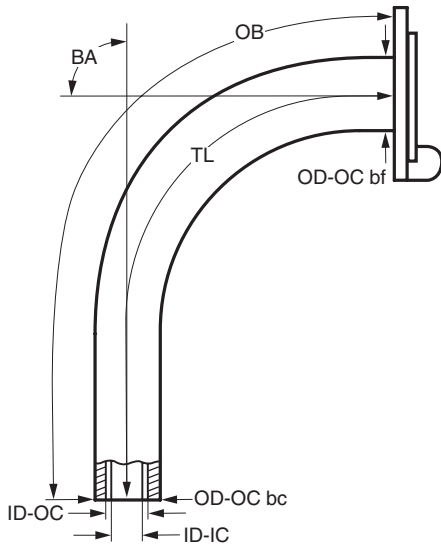

REF 201, REF 202, REF 202-D, REF 203, REF 203-O, REF 203-A, REF 204, REF 204-O, REF 204-A, REF 204-A-O, REF 205, REF 215

Size	ID-OC mm	OD-OC bc mm	OD-OC bf mm	ID-IC mm	TL mm	OB mm	BA °
05	5.0	6.6	9.0	4.0	85	92	90°
06	6.0	7.7	9.8	5.0	87	95	90°
07	7.0	8.7	10.5	6.0	93	100	90°
08	8.0	10.5	12.2	6.7	96	105	90°
09	9.0	11.5	13.0	7.5	100	110	90°
10	10.0	12.5	14.5	8.8	104	115	90°
11	11.0	13.5	15.5	9.2	108	120	90°
12	12.0	14.4	16.4	10.0	112	125	90°
13	13.0	15.4	18.0	11.8	116	130	90°
14	14.0	16.4	18.2	12.6	122	135	90°

## TRACOE *comfort* plus

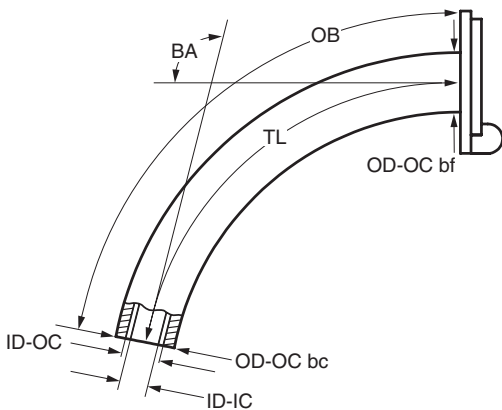

REF 157, REF 158, REF 164

Size	ID-OC mm	OD-OC bc mm	OD-OC bf mm	ID-IC mm	TL mm	OB mm	BA °
07	7.0	8.8	10.5	5.8	81	87	100°
08	8.0	10.2	11.3	6.8	84	91	100°
09	9.0	11.6	12.6	7.6	86	94	100°
10	10.0	12.0	13.7	8.7	88	97	100°
11	11.0	13.5	15.0	9.7	91	100	100°

## Scope of Supply of TRACOE *comfort* Tubes



All TRACOE *comfort* tubes are supplied with a wide adjustable neck strap and a product info card with two detachable labels.

# Product Information and Specialities

## Special Features of the Speaking Valves



### ◆ TRACOE *comfort* Speaking Valve, type A

TRACOE *comfort* tubes with type A speaking valves have a silver valve holder that is attached to the inner cannula with a chain. When necessary, it can be pulled off the inner cannula, allowing free access to the lumen, e.g. for suctioning off tracheal secretions.

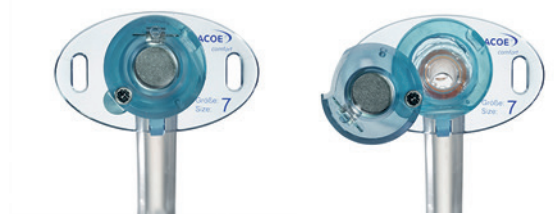

### ◆ TRACOE *comfort* Speaking Valve, type B

TRACOE *comfort* tubes with type B speaking valves have a swivelling holder that allows free access to the lumen of the inner cannula, e.g. for suctioning off tracheal secretions. The valve flap is protected from accidental distortion that would affect its function.

## Fenestration



### **TRACOE *comfort***

Standard holes for phonation can be found on the outer bend of all outer cannulas.

### **TRACOE *comfort plus***

Double fenestration leads to better phonation: *comfort plus* tubes have two additional phonation holes on the inner bend (tube length is adjusted according to the patient's increasing body mass index (BMI)). The inner cannulas are correspondingly fenestrated.



## Special Features of the 15 mm Connector and 22 mm Housing



### ◆ 15 mm connector

Universal 15mm connectors allow the use of heat/moisture exchangers and speaking valves.



### ◆ 22mm housing

Universal 22mm housing on inner cannulas give a more discreet appearance thanks to accessories with a flat profile, e.g. a flat speaking valve with silicone membrane (REF 650-S).

## Care of the Tubes

- ◆ leave in contact with cleaning solutions for only short periods (max. 1 minute)
- ◆ use clean, warm, potable tap water to rinse the tubes
- ◆ moisten the inner cannula with one drop (not more) of paraffin oil directly behind the flange

 A video clip with tips on the care of tracheostomy tubes can be found at [www.tracoe.com/en/media-library](http://www.tracoe.com/en/media-library)



## Accessories and Cleaning Products for TRACOE *comfort* and *comfort plus* Tracheostomy Tubes



### REF 902

**TRACOE *care* Liquid Paraffin** lets inner cannulas be easily inserted and removed, assures best possible fit and good quality of speech  
Details on page 102



### REF 931-A/-B

**TRACOE tube clean Cleaning Kit** with concentrated cleaning liquid REF 933  
Details on page 101



## Soft, Light, Transparent

TRACOE *larynx* is a product line intended to meet the needs of long-term tracheostomised or laryngectomised patients, in hospitals, rehabilitation, and clinical aftercare.

## The Range

TRACOE *larynx* stoma buttons and short cannulas made of soft flexible silicone have been specially developed for patients who no longer need a standard tracheostomy tube but still require a device to keep the stoma open. They also support speaking valves and/or HMEs.

# TRACOE®

*larynx*



*larynx*

TRACOE *larynx* adhesive carrier allow tracheostomised or laryngectomised patients to attach TRACOE humid assist I REF 640-CT heat/moisture exchangers (HMEs) and TRACOE phon assist I or the hands-free TRACOE phon assist II speaking valves.

All products in the TRACOE *larynx* line are DEHP-free.

Details and REF numbers of TRACOE heat/moisture exchangers and TRACOE speaking valves can be found in the TRACOE *modular* product line on page 76 onwards.



**TRACOE *larynx* Silicone Short Tube**  
with 22 mm housing

**REF 580**

Lenght: ♦ 36 mm  
Including: ♦ neck strap

**REF 582**

Lenght: ♦ 53 mm  
Including: ♦ neck strap

Silicone short tubes are ideal for the use in stable tracheostomas to secure the respiratory tract once no tracheostomy tube is needed anymore.



**TRACOE *larynx* Silicone Short Tube**  
with 22 mm housing, fenestrated

**REF 581**



Lenght: ♦ 36 mm  
Including: ♦ neck strap

**REF 583**



Lenght: ♦ 53 mm  
Including: ♦ neck strap

For tracheostomised patients as well as laryngectomised patients with a voice prosthesis.



**TRACOE *larynx* stoma button**  
made of silicone

**REF 612**

Lenght: ♦ 22 mm  
♦ in sterile package  
Sizes: ♦ 06 – 12

**REF 613**

Lenght: ♦ 30 mm  
♦ in sterile package  
Sizes: ♦ 06 – 12

**REF 601**

**TRACOE grid button**  
short, made of silicone

Including: ♦ neck strap  
♦ in sterile package  
Sizes: ♦ 06 – 12

TRACOE grid button with eyes for attaching a neck strap and with a removable grid to prevent inhalation of foreign objects.

**REF 602**

**TRACOE grid button**  
standard, made of silicone

Including: ♦ neck strap  
♦ in sterile package  
Sizes: ♦ 06 – 12

TRACOE grid button with eyes for attaching a neck strap and with a removable grid to prevent inhalation of foreign objects.

**REF 603**

**TRACOE grid button**  
long, made of silicone

Including: ♦ neck strap  
♦ in sterile package  
Sizes: ♦ 06 – 12

TRACOE grid button with eyes for attaching a neck strap and with a removable grid to prevent inhalation of foreign objects.



**REF 660**

**TRACOE *larynx* Adhesive Carrier Hydrocolloid with 22 mm housing**

- Packaging unit:
- ◆ 20 units
  - ◆ individually packaged

For affixing onto the stable tracheostoma.  
With an allergenic hydrocolloid coating, particularly suitable for patients with sensitive skin.



**TRACOE button plus**

Silicone decannulation button made of silicone

**REF 607-45**

- Length: ◆ 45 mm  
ID: ◆ 8 mm  
OD: ◆ 11 mm  
Including: ◆ neck strap  
◆ in sterile package

**REF 607-70**

- Length: ◆ 70 mm  
ID: ◆ 8 mm  
OD: ◆ 11 mm  
Including: ◆ neck strap  
◆ in sterile package

For the therapy of tracheostomised patients after long-term ventilation – safe airway after decannulation. The sealing is very airtight and dislocation save. The patient is able to cough up the stimulus secretion very fast. With the adjustable neck flange the TRACOE button plus can be positioned optimal to the soft neck tissue.

**Caution, not suitable for:**

- ◆ laryngectomised patients
- ◆ patients with unstable breathing
- ◆ patients, who primarily breathe through the tracheostoma

# Technical Data and Scope of Supply

## TRACOE *larynx* Silicone Short Tubes

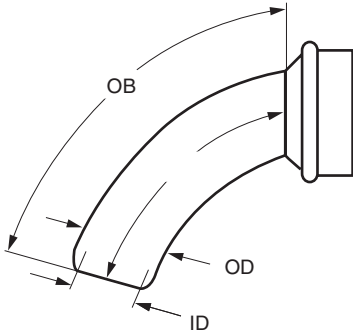

REF 580, REF 581, REF 582, REF 583

Size	ID mm	OD mm	REF 580 REF 581		REF 582 REF 583	
			TL mm	OB mm	TL mm	OB mm
08	9.5	12.0	36	43	53	62
09	10.5	13.5	36	43	53	62
10	12.0	15.0	36	43	53	62
12	13.5	17.0	36	43	53	62

## TRACOE *larynx* grid & stoma buttons

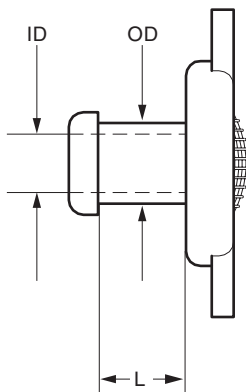

REF 601, REF 602, REF 603, REF 612, REF 613

Size	ID mm	OD mm	REF 601	REF 602 REF 612	REF 603 REF 613
			short L mm	standard L mm	long L mm
06	6	9	16	22	30
07	7	10	16	22	30
08	8	11	16	22	30
09	9	12	16	22	30
10	10	13	16	22	30
11	11	14	16	22	30
12	12	15	16	22	30

**ID:** inside diameter; **OD:** outside diameter of tube; **TL:** length along centre line; **OB:** length along outer bend; **L:** length

To order, specify **REF + size**, e. g. **REF 601-08**

## Scope of Supply of TRACOE *larynx* Products



All TRACOE *larynx* silicone short tubes, grid buttons and button plus products are supplied with a wide adjustable neck strap and a product info card with two detachable labels.



## Modular System

Depending on the requirements and indications, TRACOE speaking valves and HMEs can be attached to different support systems with 15mm connectors or 22mm housings. This modular system for tracheostomy tubes, TRACOE *larynx* stoma buttons, short tubes, and adhesive carriers allows personalised solutions for individual patients.

## Speaking Valves

The TRACOE phon assist I speaking valve is used by tracheostomised patients and, thanks to its infinitely adjustable airway resistance, offers new therapeutic options, e.g. for weaning from ventilation, improving oropharyngeal perception, and voice projection for children using 'Find the Voice'. Now also available in orange. The bright orange colour is unmistakable and immediately distinguishes the speaking valve from other attachments.





## Heat/Moisture Exchangers

The TRACOE phon assist II speaking valve offers laryngectomised patients with a voice prosthesis and tracheostomised patients the possibility of hands-free speech. Both valves can be individually adjusted by the patient.

TRACOE humid assist I to IV and the TRACOE humid assist *kids* are a variety heat/moisture exchangers (HMEs) that act like an artificial nose to filter, warm and moisten inhaled air.

# Accessories for 15 mm Connector

## Speaking Valves

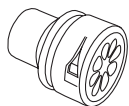

REF 650-T

TRACOE phon assist I

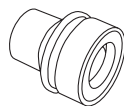

REF 655-T

TRACOE phon assist II

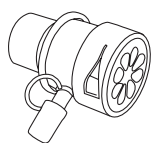

REF 650-TO

TRACOE phon assist I  
with oxygen supply port

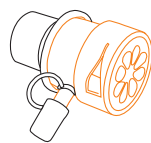

REF 650-TO-C

TRACOE phon assist I  
in a bright colour and  
with oxygen supply port

## Occlusion Cap

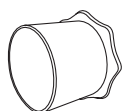

REF 516

TRACOE *modular* Occlusion Cap

Products listed here are intended exclusively for use with fenestrated tracheostomy tubes with a 15 mm connector. If a cuffed tube is being used, the cuff must be deflated before a speaking valve or occlusion cap is attached.

## Heat/Moisture Exchangers, HME

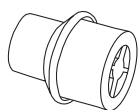

REF 640-CT

TRACOE humid assist I

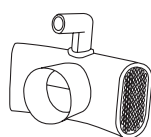

REF 641

TRACOE humid assist III

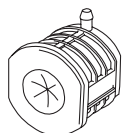

REF 642

TRACOE humid assist IV



REF 643

TRACOE humid assist *kids*



## 22 mm Housing Adapter

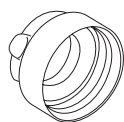

REF 622

TRACOE *modular*  
22 mm Housing Adapter

# Accessories for 22 mm Housing

## Speaking Valves



**REF 650-S**

**TRACOE phon assist I**

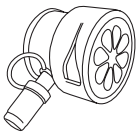

**REF 650-SO**

**TRACOE phon assist I  
with oxygen supply port**

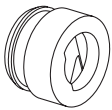

**REF 655-S**

**TRACOE phon assist II**

## Stopper

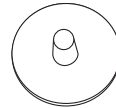

**REF 621**

**TRACOE modular stopper**

**Caution: Not for use with adhesive carrier  
REF 660!**

All the speaking valves and occlusion caps illustrated here can be fitted to fenestrated short silicone tubes, tracheostomy tubes, stoma and grid buttons, and the adhesive carrier with 22 mm housing.

## Heat/Moisture Exchanger, HME



**REF 640-S**

**TRACOE humid assist I**

## Heat/Moisture Exchanger, HME for Speaking Valve REF 655-T and REF 655-S

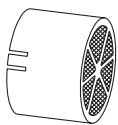

**REF 645**

**TRACOE humid assist II**

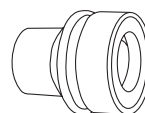

**REF 655-T**

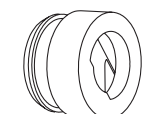

**REF 655-S**

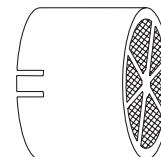

**REF 645**

This heat/moisture exchanger is intended exclusively for use with the hands-free speaking valves REF 655-T and REF 655-S.



REF 650-T



**TRACOE phon assist I Speaking Valve**  
with air supply from the side, infinitely adjustable, for attachment to any fenestrated tube with 15 mm connector

- Packaging unit:
- ◆ 1 unit
  - ◆ in sterile package

**Caution: Not for use by laryngectomised patients!**



REF 650-TO



**TRACOE phon assist I Speaking Valve**  
with oxygen supply port and air supply from the side, infinitely adjustable, for attachment to any fenestrated tube with 15 mm connector

- Packaging unit:
- ◆ 1 unit
  - ◆ 5 units, under **REF 650-TO-5**
  - ◆ sterile, individually packaged
- Including:
- ◆ adapter for oxygen supply

**Caution: Not for use by laryngectomised patients!**



REF 650-TO-C



**TRACOE phon assist I Speaking Valve**  
in a bright colour, with oxygen supply port and air supply from the side, infinitely adjustable, for attachment to any fenestrated tube with 15 mm connector

- Packaging unit:
- ◆ 1 unit
  - ◆ 5 units under **REF 650-TO-C-5**
  - ◆ sterile, individually packaged
- Including:
- ◆ adapter for oxygen supply

**Caution: Not for use by laryngectomised patients!**



More information in our product video on our website  
[www.tracoe.com/en/media-library](http://www.tracoe.com/en/media-library)



REF 650-S

**TRACOE phon assist I Speaking Valve**

with air supply from the side, infinitely adjustable, with flat base for attachment to any fenestrated silicone short tube, tracheostomy tube, stoma & grid buttons and adhesive carrier with 22 mm housings

Packaging unit: ♦ 1 unit  
 ♦ in sterile package

**Caution: Not for use by laryngectomised patients!**



REF 650-SO

**TRACOE phon assist I Speaking Valve**

with oxygen supply port and with air supply from the side, infinitely adjustable, with flat base for attachment to any fenestrated silicone short tube, tracheostomy tube, stoma & grid buttons and adhesive carrier with 22 mm housings

Packaging unit: ♦ 1 unit  
 ♦ in sterile package  
 Including: ♦ adapter for oxygen supply

**Caution: Not for use by laryngectomised patients!**

## Speaking and Therapy Valve

With the TRACOE phon assist I the airway resistance can be adjusted individually thanks to the infinitely adjustable air supply from the side. Exhalation is partly through the side openings and partly through the natural airway. The more the side holes are closed, the more the patient breathes through the natural airway. All phon assist I speaking valves REF 650-TO, REF 650-TO-C and REF 650-SO with oxygen supply lines allow the additional administration of oxygen when required.

## Examples of Use

- ♦ to reduce air-trapping during weaning from the ventilator:  
 by individually adjusting the side openings, expiration can be made easier for the patient
- ♦ in early rehabilitation, to improve oropharyngeal perception,  
 i.e. the patient's mouth and throat become more sensitive and the swallowing reflex is stimulated
- ♦ for speaking with a tracheostomy tube in situ (fenestrated and with deflated cuff)
- ♦ 'Find the Voice' – simplified speech training through individual adjustment of the side openings  
 (particularly useful for children)



REF 655-T



**TRACOE phon assist II Hands-free Speaking Valve**  
infinitely adjustable, for attachment to any fenestrated tube with 15 mm connector

- Packaging unit: ♦ 1 unit  
Including: ♦ 5 units TRACOE humid assist II (REF 645)  
♦ sterile, individually packaged

**Caution: After laryngectomy only to be used in conjunction with a voice prosthesis!**



REF 645

**TRACOE humid assist II Heat & Moisture Exchanger**  
with foam filter for attaching to the TRACOE phon assist II hands-free speaking valves REF 655-T and REF 655-S only

- Packaging unit: ♦ 50 units  
♦ sterile, individually packaged



REF 516

**TRACOE modular Occlusion Cap**  
for attachment to any fenestrated tube with 15 mm connector

- Packaging unit: ♦ 5 units  
♦ sterile, individually packaged

**Caution: Not for use by laryngectomised patients!**

REF 655-S



**TRACOE phon assist II Hands-free Speaking Valve** infinitely adjustable, with flat base for attachment to any fenestrated silicone short tube, tracheostomy tube, stoma & grid buttons and adhesive carrier with 22 mm housings

- Packaging unit ♦ 1 unit  
Including: ♦ 5 units TRACOE humid assist II (REF 645)  
♦ sterile, individually packaged

**Caution: After laryngectomy only to be used in conjunction with a voice prosthesis!**

**Examples of Use for REF 645**



REF 645 + REF 655-T



REF 645 + REF 655-S

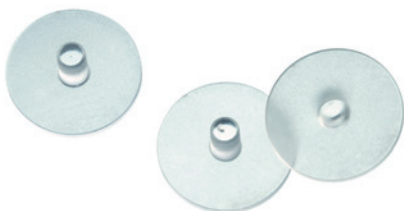

REF 621

**TRACOE modular Stopper** to temporarily seal fenestrated silicone short tube, tracheostomy tube, stoma & grid buttons with 22 mm housings, in patients with unobstructed upper airways and unrestricted breathing

- Packaging unit: ♦ 5 units  
♦ sterile, individually packaged

**Caution: Not for use by laryngectomised patients!**



**REF 640-CT**

**TRACOE humid assist I Heat & Moisture Exchanger** with foam filter for attachment to any tube with 15 mm connector

- Packaging unit: ♦ 50 units  
♦ sterile, individually packaged



**REF 641**

**TRACOE humid assist III Heat & Moisture Exchanger** with paper filter, integrated oxygen supply port, turnable through 360°, for attachment to any tube with 15 mm connector

- Packaging unit: ♦ 50 units  
♦ sterile, individually packaged



**REF 642**

**TRACOE humid assist IV Heat & Moisture Exchanger** with foam filter, integrated oxygen supply port and pressure control valve for expectoration of larger quantities of secretion, for attachment to any tube with 15 mm connector

- Packaging unit: ♦ 30 units  
♦ individually packaged





REF 643



**TRACOE humid assist *kids* Heat & Moisture Exchanger** with paper filter, for attachment to any pediatric tube with 15 mm connector, to be used in children with tidal volume of 7 to 50 ml

Packaging unit: ♦ 50 units  
♦ sterile, individually packaged



REF 640-S

**TRACOE humid assist I Heat & Moisture Exchanger** with foam filter and with flat base for attachment to any fenestrated silicone short tubes, tracheostomy tubes and stoma & grid buttons with 22 mm housings

Packaging unit: ♦ 50 units  
♦ sterile, individually packaged

**For patients with or without voice prosthesis.**



REF 622

**TRACOE modular 22 mm Housing Adapter** for tubes with 15 mm connector

Packaging unit: ♦ 1 unit



## Cuff Pressure Management

TRACOE *technic* refers to medical devices that allow the pressure in the cuffs of tracheostomy and endotracheal tubes to be set or independently regulated with great precision.

Why is it so important that the cuff is always properly inflated? For one reason, to ensure adequate ventilation at all times.

For another, to prevent silent aspiration, which may sometimes lead to nosocomial ventilator-associated pneumonia (VAP). It also prevents damage to the trachea, for example mucosal necrosis, destruction of cartilage and tracheomalacia.



## Two Systems, One Goal

TRACOE *technic* includes two ways of regularly checking the cuff pressure. First, the TRACOE cuff pressure monitor (cpm and cpms) handheld manometers, featuring large easy-to-read dials for quick straightforward measurements. The usual pressure range is marked in green.

Or secondly, the TRACOE smart Cuff Manager, which offers a new benchmark in patient safety by continuous regulation of the pressure in the cuff. It is simple to use and the visual confirmation of optimal cuff pressure assists nursing staff in both hospitals and community settings.



**REF 730-5**

**TRACOE smart Cuff Manager**

- Packaging unit:
- ◆ 5 units
  - ◆ sterile, individually packaged

The TRACOE smart Cuff Manager monitors and regulates the internal pressure of High Volume Low Pressure cuffs of tracheostomy tubes as well as endotracheal tubes.

The pressure is maintained between 20cmH<sub>2</sub>O and 30cmH<sub>2</sub>O. Visual verification of the cuff pressure is indicated by the inflation level of the blue buffer ball of the TRACOE smart, which should be inflated between 2/3 and 3/4. Additional checks of the cuff pressure may be performed with a cuff pressure manometer (e.g. TRACOE cpm REF 720). If the cuff pressure is too low, the TRACOE smart Cuff Manager refills the cuff quickly to its appropriate pressure.

Short high pressure peaks e.g. due to coughing will be tolerated by the integrated damping function which inhibits that air escapes instantly from the cuff. The solid shell of the TRACOE smart protects the highly elastic blue balloon from unwanted compression.

TRACOE smart is a latex- and DEHP-free, single patient product with a usage time of 29 days after opening.

 More information in our product video on our website [www.tracoe.com/en/media-library](http://www.tracoe.com/en/media-library)

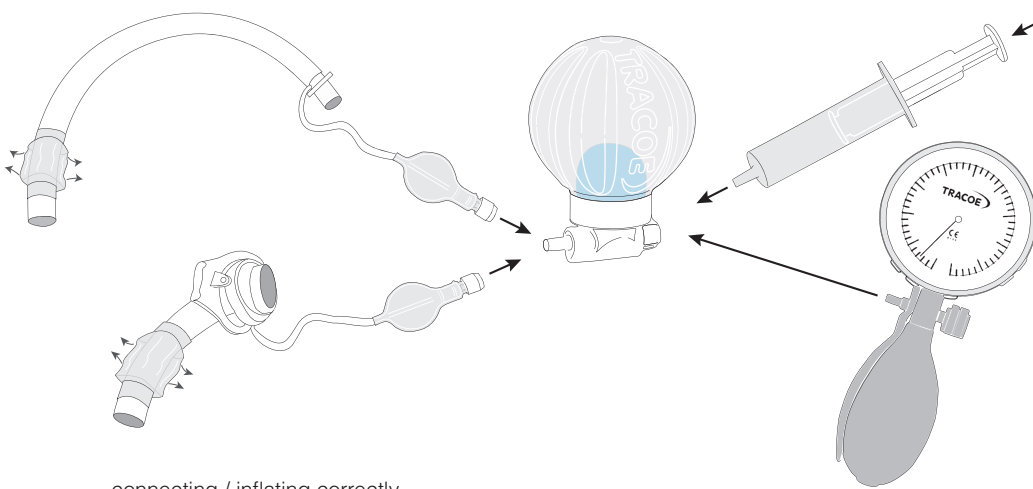
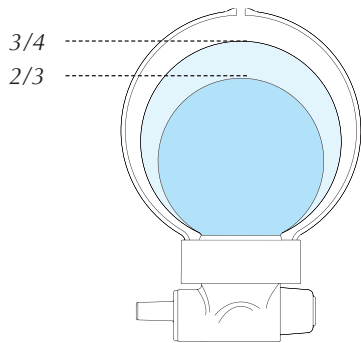

connecting / inflating correctly

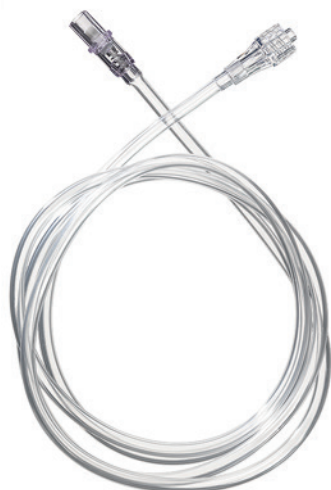
**REF 702****TRACOE *technic* Connection Tube**

1 m length with check valve

- Length:                   ◆ 1 m  
Packaging unit:       ◆ 10 units  
                                  ◆ sterile, individually packaged

Tubes for connecting the TRACOE cpm REF 720, TRACOE cpms REF 721 or TRACOE smart Cuff Manager REF 730-5 to a tracheostomy or endotracheal tube with Luer lock connectors.



The subglottic secretion suction with the aim to reduce the VAP rate of patients with an expected ventilation period of more than 72 hours was classified as category IA of the recommendations by the German Commission for Hospital Hygiene and Infectious Disease Prevention (guidelines for hospital hygiene and infection prevention issued by the Robert Koch Institute, KRINKO)\*. The recommendation specifies that the cuff pressure level should be set between 20 and 30 cmH<sub>2</sub>O and checked at regular intervals. The recommendation is part of category IB. When these two actions are taken in combination, they can help to reduce the incidence of pneumonia.

\* Prevention of nosocomial ventilator-associated pneumonia (KRINKO), German Federal Health Gazette 2013 – 56:1578-1590



**REF 720**

**TRACOE cuff pressure monitor (cpm)**

- Packaging unit:     ◆ 1 unit  
 Including:           ◆ 1 connection tube REF 702

The TRACOE cuff pressure monitor (cpm) is used to fill and monitor the pressure of high-volume-low-pressure cuffs of tracheostomy and endotracheal tubes.

Its outstanding features and benefits:

- ◆ easy use
- ◆ precise, reproducible pressure indication
- ◆ extra-large, easy-to-read scale from 0 – 100 cmH<sub>2</sub>O
- ◆ widely spaced scale markings with colour coded pressure ranges
- ◆ stable metal hook for attachment



**REF 721**

**TRACOE cuff pressure monitor sensitive (cpms)**

- Packaging unit:     ◆ 1 unit  
 Including:           ◆ 1 connection tube REF 702

The TRACOE cuff pressure monitor sensitive (cpms) is used to fill and monitor the pressure of high-volume-low-pressure cuffs of tracheostomy and endotracheal tubes.

Its outstanding features and benefits:

- ◆ easy and safe in- and deflation
- ◆ precise, reproducible pressure indication
- ◆ sensitive adjustment of cuff pressure by red pressure button
- ◆ easy-to-read scale with green colour coded pressure range between 20 and 30 cmH<sub>2</sub>O (from 0 – 120 cmH<sub>2</sub>O)
- ◆ stable/solid and flexible fastening hook
- ◆ vacuum valve for deflation

**REF 725**

**TRACOE high pressure inflation device**

Packaging unit: ♦ 1 unit

The TRACOE high pressure inflation device is recommended for filling and emptying the balloon and for monitoring the pressure in the balloon during dilatation procedures.

Components:

- ♦ ratchet lever to control the piston
- ♦ pressure gauge with scale marked in intervals of 1 bar
- ♦ connection tube with rotatable adapter

The disposable plastic instrument is delivered sterile and must be used only with liquid inflation media. It is intended for single use in one patient only.

**Warning: Not suitable for use with high-volume-low-pressure cuffs.**





## Superlative Quality

The name of TRACOE medical has always stood for uncompromising quality, in-house Research and Development, and superior handcraftsmanship. Year by year, we are improving our skills and have developed a meticulous eye for detail, bringing added value for both doctors and patients.

With the same stringent approach, we are opening up our product portfolio and, after careful examination of external know-how, we can now offer you even more products than in the field of tracheostomy and laryngectomy. You will find selected medical devices that meet our firm concepts of quality and user-friendliness listed in the TRACOE *select* product range.





# TRACOE®

*select*

## Trust is the Key

We will be including products that have proved themselves in routine clinical practice, as we want you and your patients to have nothing but the best – just as you are accustomed to when using our products. We have already found two such products in the TRACOE aeris® balloon dilatation catheter and the TRACOE seldinger pleural drainage set.

## Open to New Ideas and Products

An open exchange with doctors and hospitals has made us aware of your incentives and requirements and, with *select*, we are responding to both your individual and collective needs. We will continue to assess your suggestions and requests.

TRACOE *select*: always one step ahead!



**REF 820**

**TRACOE aeris® Balloon Dilation Catheter**

Packaging unit: ♦ 1 unit

The TRACOE aeris balloon dilatation catheter is intended for dilating strictures in the airways. Minimally invasive balloon dilatation is an effective atraumatic method of treatment for stenoses.

The set's features include:

- ♦ innovative non-slip design (two hubs distally and proximally at the ends of the balloon for fixation)
- ♦ absolutely precise, secure placement
- ♦ controlled radial dilatation
- ♦ maintenance of constant pressure against the stenosis

Colour coding of the connections correspond to markers on the TRACOE high pressure inflation device REF 725 to ensure the correct pressure settings.

Dilatation can be repeated several times in succession during the procedure. The balloon is filled using the TRACOE high pressure inflation device REF 725, which is safe and easy to use.

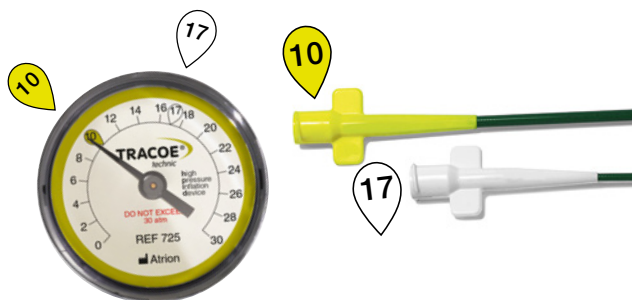

**Accessories for Inflating the TRACOE aeris® Balloon Dilation Catheter**

**Technical Data**



**REF 725**

**TRACOE high pressure inflation device**  
for use with the TRACOE aeris® balloon dilation catheter  
Details of the product are given in the *technic* product line on page 91

Size	Balloon Size (diameter x length) in mm	max. Inflation Pressure atm
05	5 x 30	17
06	6 x 30	17
07	7 x 30	17
08	8 x 30	17
09	9 x 30	17
10	10 x 30	17
12	12 x 40	10
14	14 x 40	10
16	16 x 40	10
18	18 x 40	10

To order, specify: **REF + Size**, e. g. **REF 820-08**

More information in our product video on our website [www.tracoe.com/en/media-library](http://www.tracoe.com/en/media-library)

REF 850-5

**TRACOE Pleural Drainage Set  
 using the Seldinger Technique**

The seldinger pleural catheter is used for draining pleural effusion and to relieve a pneumothorax.

Packaging unit:

◆ 5 units

Including:

- ◆ 1 drainage catheter with inner stylet (12 Fr), radiopaque, kink-resistant due to plastic spiral reinforcement, MR conditional, luer lock connector
- ◆ 2 scalpel (11), single use
- ◆ 3 syringe (10ml)
- ◆ 4 tuohy puncture needle (1.2 x 1.5 x 90mm, Gauge 17)
- ◆ 5 coated seldinger guide wire with Nitinol core
- ◆ 6 dilator with depth limiter (12 Fr)
- ◆ 7 fixation plaster
- ◆ 8 3-way-valve
- ◆ 9 adapter from luer lock to funnel connector
- ◆ 10 secretion bag (1.5l) with luer lock connection

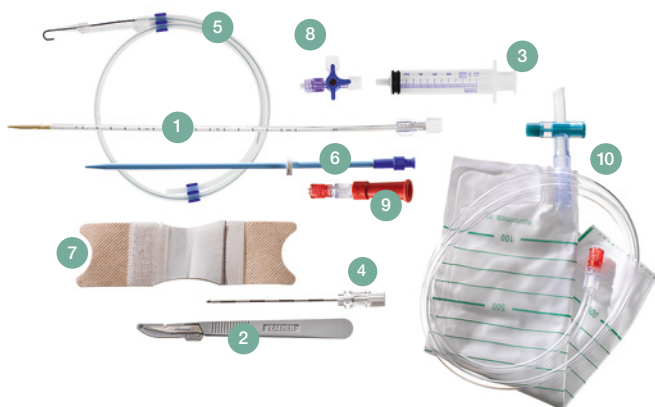

The set's features include:

- ◆ kink-resistant, thin drainage catheter (12 Fr) with embedded plastic spiral reinforcement
- ◆ extra-soft catheter tip with three staggered openings
- ◆ tuohy puncture needle
- ◆ seldinger guide wire, kink-resistant due to Nitinol core
- ◆ convenient thumb inserter
- ◆ maximum in situ usage time of 28 days
- ◆ radiopaque and MR conditional



More information in our product video on our website  
[www.tracoe.com/en/media-library](http://www.tracoe.com/en/media-library)



## Tracheostoma Management – as Comfortable as Possible

Tracheostomised and laryngectomised patients require aids that make living with a tube as comfortable as possible. A wide range of accessories is available for the best possible care of tracheostomy tubes and stomas.

Many items in the TRACOE care product line, such as neck straps and compresses, help in daily living with a TRACOE tracheostomy tube.



## Special Protection

Tracheal compresses can be used, for example, to provide padding between the tube and the stoma; they also absorb secretions coming from the stoma. Other products, such as special cleaning sets and brushes, help to maintain the extremely important high standards of hygiene. A well-cared tracheostoma ensures that the patient feels comfortable and reduces the complications.

Bibs, scarves, and roll-necks can help to replace the missing protective and filtration functions of the nose. They protect the airway from dryness, cold and dust but also act as coverings to improve the patient's appearance.



**REF 903-A**

**TRACOE care Neck Strap**

white, elastic, consists of one part, individually adjustable, with hook

- Packaging unit:     ◆ 1 unit  
Dimensions:         ◆ max. length approx. 44 cm  
                          ◆ width of neck strap approx. 1.5 cm



**REF 903-B**

**TRACOE care Neck Strap**

padded, adjustable in length, latex-free, with hook-and-loop fastener

- Packaging unit:     ◆ 1 unit  
                          ◆ 10 units under **REF 903-B-P**  
Dimensions:         ◆ max. length approx. 45 cm  
                          ◆ width of neck strap approx. 3.0 cm



**REF 903-D**

**TRACOE care Neck Strap**

white, wide, padded, elastic, consists of two parts, individually adjustable, with hook-and-loop fastener

- Packaging unit:     ◆ 1 unit  
Dimensions:         ◆ max. length approx. 49 cm  
                          ◆ width of neck strap approx. 2.5 cm



**REF 903-E**

**TRACOE care Neck Strap**

white, wide, consists of one part, with hook-and-loop fastener

- Packaging unit: ♦ 1 unit  
♦ 10 units under **REF 903-E-P**
- Dimensions: ♦ max. length approx. 42 cm  
♦ width of neck strap approx. 3.5 cm



**REF 903-F**

**TRACOE care Neck Strap**

white, wide, consists of two parts, individually adjustable, with hook-and-loop fastener

- Packaging unit: ♦ 1 unit  
♦ 10 units under **REF 903-F-P**
- Dimensions: ♦ max. length approx. 43 cm  
♦ width of neck strap approx. 2.6 cm



**REF 903-G**



**TRACOE care Neck Strap**

white, padded, consists of two parts, individually adjustable, with hook-and-loop fastener, for neonates, infants and children

- Packaging unit: ♦ 1 unit
- Dimensions: ♦ max. length approx. 29 cm  
♦ width of neck strap approx. 2.6 cm

**TRACOE care Neck Straps**

Ordering Number	max. Length (approx.)	Width (approx.)	Packaging Unit
	cm	cm	
REF 903-A	44	1.5	1 unit
REF 903-B	45	3.0	1 unit
REF 903-B-P	45	3.0	10 units
REF 903-D	49	2.5	1 unit
REF 903-E	42	3.5	1 unit
REF 903-E-P	42	3.5	10 units
REF 903-F	43	2.6	1 unit
REF 903-F-P	43	2.6	10 units
REF 903-G	29	2.6	1 unit



**TRACOE tube clean Cleaning Kit**  
with cleaning powder REF 932

**REF 930-A** ♦ with 50 small cleaning swabs (REF 935)

**REF 930-B** ♦ with 50 large cleaning swabs (REF 936)

Including: ♦ tube clean cleaning tub with mesh basket (REF 934)  
♦ 1 cleaning brush (REF 938-A)

For cleaning and maintaining tracheostomy tubes, stoma and grid buttons and the corresponding spare parts and accessories.



**REF 932**

**TRACOE tube clean Cleaning Powder**

Contents: ♦ 400 g

Cleaning powder for cleaning and maintaining tracheostomy tubes, stoma and grid buttons and the corresponding spare parts and accessories.  
approx. 80 applications, approx. 5g/500ml water



**REF 935**

**TRACOE tube clean Cleaning Swabs small**

Packaging unit: ♦ 50 units

Bendable plastic swabs with polyurethane sponge tip for cleaning tracheostomy tubes with an inner diameter of 3 – 7 mm. For single use.



**REF 934**

**TRACOE tube clean Cleaning Tub**  
with mesh basket

Volume: ♦ 1000 ml

For use with the solution, to clean tracheostomy tubes, stoma and grid buttons and the corresponding spare parts and accessories.





**TRACOE tube clean Cleaning Kit**  
with concentrated cleaning liquid REF 933

**REF 931-A** ◆ with 50 small  
cleaning swabs (REF 935)

**REF 931-B** ◆ with 50 large  
cleaning swabs (REF 936)

Including: ◆ tube clean cleaning tub (REF 934)  
◆ 1 cleaning brush (REF 938-A)

For quick cleaning and maintaining tracheostomy tubes,  
stoma and grid buttons and the corresponding spare parts  
and accessories.



**REF 933**

**TRACOE tube clean Concentrated Cleaning Liquid**

Contents: ◆ 250 ml

Liquid cleaning concentrate for cleaning and maintaining  
tracheostomy tubes, stoma and grid buttons and the  
corresponding spare parts and accessories. The contain-  
ing enzymes penetrate and dissolve all organic residues.  
Rapidly acting.  
approx. 100 applications, approx. 2.5 ml/500ml water



**REF 936**

**TRACOE tube clean Cleaning Swabs large**

Packaging unit: ◆ 50 units

Bendable plastic swabs with polyurethane sponge tip  
for cleaning tracheostomy tubes with an inner diameter of  
8 – 14mm. For single use.

▶ More information about our cleaning products  
in our product video on our website  
[www.tracoe.com/en/media-library](http://www.tracoe.com/en/media-library)



**REF 938**

**TRACOE care Cleaning Brushes** with microfibre tip

Packaging unit: ♦ 10 units

Ordering Number	Bristle-diameter mm	for tube Inside Diameter mm	approx. Total Length mm
938-A	7	5/6	210
938-B	9	7/8	210
938-C	11	9/10	210

Angled brush with extra-soft nylon bristles for removing incrustations. To reduce scratching, the brushes have a microfibre tip.



**REF 902**

**TRACOE care Paraffin**

Contents: ♦ 25 ml

Lubricates and protects TRACOE *comfort* tubes. Lets inner cannulas be easily inserted and removed, assures best possible fit and good quality of speech.



**REF 677**

**TRACOE care Lubricating Gel**

Packaging unit: ♦ 30 Sachets à 2.7 g  
♦ sterile

Before placing tracheostomy tubes and/or endotracheal tubes slightly coat them with the lubricating gel. The perfectly dosed gel is colour- and odorless, greaseless, water-soluble and does not stick.



**REF 970**

**TRACOE care Skin Cloth**

Packaging unit: ♦ 50 units

For daily cleansing and care around the stoma: pH-balanced skincare products with a pH of 5.0 – 5.5.

**REF 940**

**TRACOE care Cleaning Brushes flexible**

Packaging unit: ◆ 10 units

Ordering Number	Bristle-diameter mm	for tube Inside Diameter mm	approx. Total Length mm
940-A	7	5/6	315
940-B	9	7/8	335
940-C	11	9/10	360
940-D	13	11/12	360

Extra-long, specially made for cleaning flexible tracheostomy tubes. The wire used has a rounded tip and the bristles are made of soft nylon.



**REF 915**

**TRACOE care Shower Guard**

Silicone shower protector, contains no DEHP or latex. Soft, adjustable, and can be adapted to different-sized necks.

**Caution: May not be used for full-body bathing or swimming!**



**TRACOE care Tracheostoma Protection**

**REF 908**

Dimensions: ◆ approx. 6 x 6.5 cm

Packaging unit: ◆ 10 units

**REF 909**

Dimensions: ◆ approx. 7.2 x 7.2 cm

Packaging unit: ◆ 10 units

Prevents foreign objects from entering the tracheostoma. With adhesive strip, for single use, for adults and children.





**REF 905**

**TRACOE care Tracheal Compresses**  
aluminium coated, with zigzag slit

Dimensions:           ◆ approx. 9 x 9.8 cm  
Packaging unit:       ◆ 10 units

Tracheal compresses, aluminium coated, avoid the compress sticking to the wound or the skin. They absorb secretions between the stoma and the tube.



**TRACOE care Tracheal Compresses two-ply**

**REF 907-A**   without slit

**REF 907-B**   with zigzag slit

Dimensions:           ◆ approx. 9 x 9.8 cm  
Packaging unit:       ◆ 10 units

Two-ply tracheal compresses absorb a large amount of secretions from the tracheostoma quickly to avoid skin irritations. At the same time they are used as a pad between the tracheostoma and the tracheostomy tube.



**TRACOE care Tracheal Compresses**

**REF 910-A**   without slit

**REF 910-B**   with zigzag slit

Dimensions:           ◆ approx. 9 x 9.8 cm  
Packaging unit:       ◆ 10 units

These tracheal compresses absorb secretions from the tracheostoma to avoid skin irritations.

**REF 957****TRACOE care Coated Tracheal Compresses**  
two-ply, with zigzag slit

Dimensions: ◆ approx. 9 x 10 cm  
Packaging unit: ◆ 10 units

Two-ply tracheal compresses absorb a large amount of secretions from the tracheostoma quickly to avoid skin irritations. The absorbent coating further avoids the compress sticking to the wound or skin. At the same time they are used as a pad between the tracheostoma and the tracheostomy tube.

**REF 960****TRACOE care Coated Tracheal Compresses**  
with zigzag slit

Dimensions: ◆ approx. 8 x 10 cm  
Packaging unit: ◆ 10 units

To absorb secretions from the tracheostoma to avoid skin irritations. The coating further avoids the absorbant compress sticking to the wound or the skin.

**REF 961****TRACOE care Tracheal Compresses**  
with zigzag slit, for neonates, infants and children

Dimensions: ◆ approx. 6.5 x 6.3 cm  
Packaging unit: ◆ 10 units

To absorb secretions from the tracheostoma. At the same time they are used as a pad and a protection for the sensitive skin around the tracheostoma. The compresses are ideally adapted to the anatomy of neonates and children.

**REF 969**

**TRACOE care softpad Tracheostomy Stoma Pads oval**



- Dimensions: ♦ approx. 5.8 cm x 3.6 cm  
 Packaging unit: ♦ 20 units  
 ♦ sterile, individually packaged

Oval tracheostomy stoma pads made of open-pored, highly absorbent polyurethane foam. Avoids decubitus, compensates unevenness due to scars, seals air leaks (function of speech).

**TRACOE purofoam Tracheostomy Dressings with zigzag slit**



**REF 958** large

- Dimensions: ♦ approx. 9 x 10 x 0.5 cm  
 Packaging unit: ♦ 10 units  
 ♦ sterile, individually packaged

For tracheostomy tube sizes 06 – 12.



**REF 959** small

- Dimensions: ♦ approx. 6.5 x 6.5 x 0.5 cm  
 Packaging unit: ♦ 10 units  
 ♦ sterile, individually packaged

For tracheostomy tube sizes 03 – 05.



**Features of TRACOE purofoam Tracheostomy Dressing REF 958 and REF 959:**

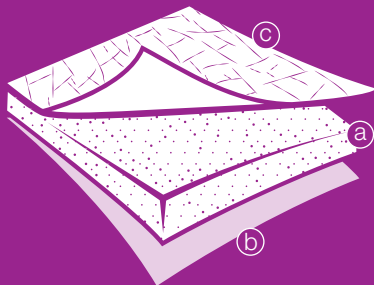

The TRACOE purofoam tracheostomy dressings are made of highly absorbent open pore polyurethane foam (a).  
 The foam has a non-sticking layer (b) on the side facing the tracheostoma which allows quick absorption of liquids into the foam's core. A net-like film stabilises the purofoam dressings and thus reduces the deformation with strong secretion after the moisture absorption.  
 The opposite side is covered with a skin coloured, vapour permeable coating which will prevent leakage of secretions and bacteria through the front of the dressing (c).

Due to the circular opening and the zigzag slit the dressing can be easily replaced with a new one whilst wearing the tracheostomy tube. As the dressing does not stick to the skin, it can be removed and replaced without causing trauma or pain. The TRACOE purofoam tracheostomy dressing can be used to dress a newly established or an existing, irritated tracheostoma, as well as healed but weeping tracheostomas and any other kind of artificial orifice. This dressing meets modern standards of moist wound treatment.



**TRACOE care Protective Bibs white**

**REF 919-A** 3-ply

**REF 919-B** 6-ply

**REF 919-C** 12-ply

The protective bibs filter and warm the respiratory air. At the same time they protect clothes from possible secretions. Made of polyester, with continuously adjustable hook-and-loop fastener.



**TRACOE care Protective Scarves**

in different colours: gray plaid, beige plaid, dark green, dark blue, burgundy

**REF 921-A** 

**REF 921-D** 

**REF 921-B** 

**REF 921-E** 

**REF 921-C** 

Made of 100% viscose with integrated polyester layer. The TRACOE protective scarves are worn around the neck like an average scarf and are secured with an continuously adjustable hook-and-loop fastener.



**TRACOE care Protective Roll-Necks**

in different colours: white, gray, beige, dark green, dark blue, burgundy, black

**REF 923-A** 

**REF 923-E** 

**REF 923-B** 

**REF 923-F** 

**REF 923-C** 

**REF 923-G** 

**REF 923-D** 

TRACOE protective roll-necks are made of 100% cotton with an integrated polyester layer. They are worn underneath the shirt.

Contact the TRACOE Product Specialist for your Country!

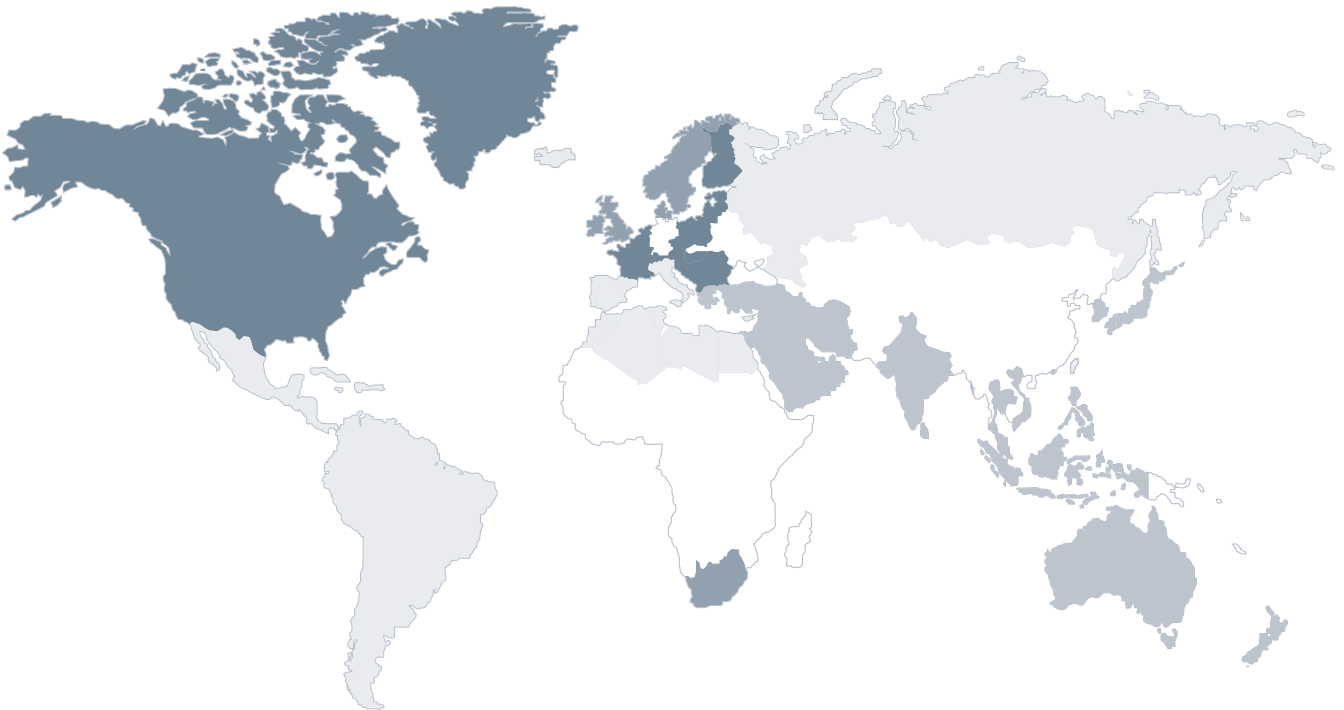

■ Eastern Europe, France, USA, Canada  
Mobile: +49 162 271 7004

■ Australia, New Zealand, Asia, Japan, The Middle East  
Mobile: +49 175 904 1644

■ Scandinavia, United Kingdom, South Africa, Ireland  
Mobile: +49 151 5500 4391

■ Italy, Spain, Portugal, Latin America, Northern Africa  
Mobile: +49 160 843 7917



Any questions about orders or delivery?  
Please contact our customer service team at:

International

☎ Phone: +49 6136 9169-320

☎ Fax: +49 6136 9169-289

✉ [order@tracoe.com](mailto:order@tracoe.com)

Germany

☎ Phone: +49 6136 9169-310

☎ Fax: +49 6136 9169-288

✉ [bestellung@tracoe.com](mailto:bestellung@tracoe.com)



## Visit our Website!

To obtain information easily and quickly about TRACOE products, new additions or general information, visit our website: [www.tracoe.com/en](http://www.tracoe.com/en)

Our media library contains useful videos about the use and cleaning of certain products: [www.tracoe.com/en/media-library](http://www.tracoe.com/en/media-library)

You can also find us on Facebook and YouTube.



### Product Training

We will be happy to support you with seminars and workshops on special topics. Our website has details of contact persons in the hospital and community segments:

[www.tracoe.com/en/contact/product-training](http://www.tracoe.com/en/contact/product-training)

### Delivery

All TRACOE products are shipped directly ex stock. Non-sterile product variants are generally shipped within 14, sterile ones within 28 days. Please note: Additional freight charges apply in cases of express deliveries and deliveries to addresses which differ from the address on the invoice.

### Returns

Returns of used products can be accepted only if accompanied by a completed decontamination certificate and a claim form. You can obtain the necessary certificate and form either directly from TRACOE medical or via their website: [www.tracoe.com/en/downloads](http://www.tracoe.com/en/downloads)

## Tips for Everyday Use of TRACOE Tracheostomy Tubes

### Cleaning and Maintenance

The easiest way to clean the tubes is to use the TRACOE tube clean cleaning kits (REF 930-A/-B or REF 931-A/B), developed especially for this purpose. Never use a strong household cleaning product, a denture cleanser, or strong alcohol to clean the tubes. Soften any solid incrustations and remove them using e.g. TRACOE tube clean cleaning swabs (REF 935 and REF 936). After cleaning, rinse the cannulas thoroughly with water in drinking water quality. Allow the inner and outer cannulas to air-dry.

### Disinfection

If necessary, clean the tubes and then soak them in a disinfectant named by TRACOE medical, available on [www.tracoe.com/en/downloads](http://www.tracoe.com/en/downloads) (observe manufacturer's instructions). Afterwards rinse the tubes thoroughly in running water in drinking water quality or with distilled water.

### Hygiene

When the tracheostoma is stable, the tubes can be cleaned and maintained during replacement. Tubes should not be removed from new tracheostomies without the help of a guide technique. These procedures should be performed only under medical supervision or on a doctor's instructions. Please note that the tube must be taken out of the tracheostoma for cleaning. Care of the stoma depends on mucous accumulation, scab formation, and skin condition, but it should be cleaned at least twice a day. Use the TRACOE *care* protective skin cloth (REF 970) to clean the stoma. Do only use fluff free material. Replace the compresses and neck straps regularly. Select the widest, softest neck strap possible to prevent irritation.

The skin should be clean and dry (neither desiccated nor waterlogged). If the area around the tracheostoma is chafed, the skin can be treated with appropriate care products according to doctor's orders. When the irritation disappears, treat the area with a skin dressing that is not excessively viscous. A tracheostoma being treated with radiation is often highly sensitive and should be cared for as instructed by your physician or healthcare personnel.



A working group from the Tracheostomy and Laryngectomy division at the German medical devices industry association (BVMed) has compiled two comprehensive brochures on the daily care and maintenance of tracheostomies, tracheostomy tubes, and the necessary accessories. They include details of the necessary measures, explain technical terms, and suggest further reading in the literature. You can find these brochures on our website: [www.tracoe.com/en/homecare/patient-information](http://www.tracoe.com/en/homecare/patient-information)

### Protective Accessories

To prevent particles of dust and dirt or other objects from entering the trachea through the stoma, special protective articles are needed such as cloths, bibs, roll-necks, filters, etc. (see product lines TRACOE *modular* and TRACOE *care*).

### Suctioning Frequency

In the same patient the necessity to suction can vary from just a few times each day to up to a number of times an hour. It is important to use a high-quality suction device with suitable performance.

### Moistening

To prevent the formation of scab, the use of an "artificial nose" (e.g. TRACOE humid assist I, REF 640-CT) to keep the airways moist is recommended.

### Materials

TRACOE tracheostomy tubes are made from materials that have worldwide approval for medical use. They do not contain any latex or any softeners such as DEHP. Products must be disposed of in accordance with national regulations for waste materials.

## Product Info Card

Most TRACOE products receive a product info card that contains important information for reordering and documentation. Two detachable labels on the front and rear side make paperwork like patient records easier. If the patient is discharged or transferred to a rehabilitation clinic, the product info card informs the medical staff taking over treatment of the product in question.

To meet the market demands of both today and tomorrow, TRACOE medical uses the globally recognised GS1 labelling standard (Global Standards One), which is also reflected in the content of the product info card.

QR code containing all information on LOT and GTIN numbers, expiry date

order number and additional information

expiry date

production data

size data

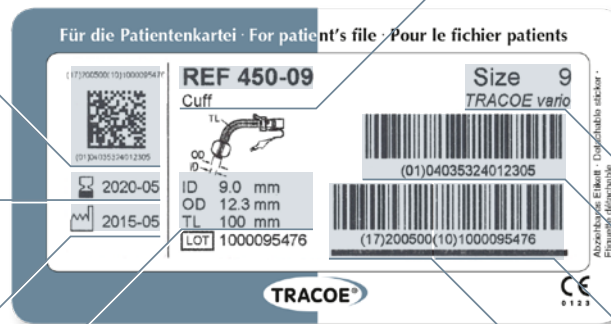

size and product group

GTIN - Global Trade Identification Number

LOT number

expiry date (YYMM00)

## News Service

In addition to our marketing material, TRACOE NEWSFLASH brings you the latest in-depth information on, for example, new products, changes, or particular aspects of the TRACOE medical product range, clearly summarised in just a few pages.

We will be happy to send you the TRACOE news by email, free and without obligation, as soon as we have anything of interest to report.

You can find the TRACOE NEWSFLASH and the order form on our website: [www.tracoe.com/en/downloads](http://www.tracoe.com/en/downloads)



# TRACOE Worldwide





TRACOE medical distributes its high quality products (most of them are 'Made in Germany') in more than 85 countries. Our worldwide success is also due to our sister company KAPITEX in the UK and our daughter company MC Europe B.V. in the Netherlands, as well as a network of international distributors.

The TRACOE international sales team looks after its partners throughout the world. Competent advice and help are always at your service.

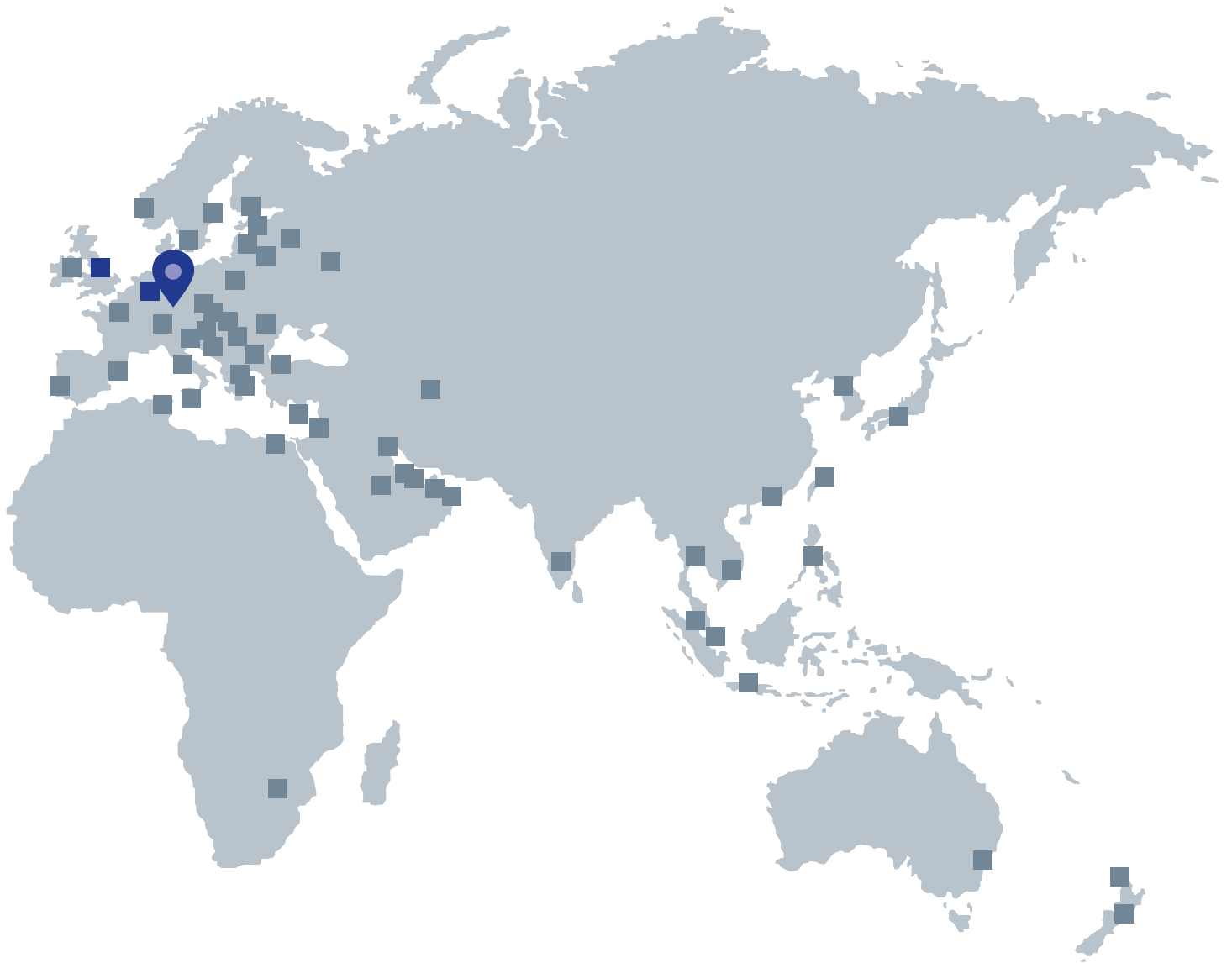

All official TRACOE distributors can be found on our website: [www.tracoe.com/en/contact/sales](http://www.tracoe.com/en/contact/sales)



 TRACOE medical GmbH

 MC Europe and KAPITEX Healthcare

 TRACOE distributors



TRACOE medical GmbH  
Reichelsheimer Str. 1 / 3  
55268 Nieder-Olm  
Germany

Phone: +49 6136 9169-0  
Fax: +49 6136 9169-200

info@tracoe.com  
www.tracoe.com



Kapitex Healthcare Ltd.  
Unit 1 Erivan Park  
Sandbeck Way, Wetherby  
West Yorkshire, LS22 7DN  
Great Britain  
www.kapitex.com

MC Europe B.V.  
Roermondseweg 82  
6004 AT Weert  
Netherlands  
www.mc-europe.nl